

The background of the entire page is a photograph of several golden wheat stalks with long, thin awns, set against a clear, bright blue sky. The wheat stalks are positioned in the lower half of the frame, with some in sharp focus and others slightly blurred, creating a sense of depth. The text is overlaid on this image in a clean, white, sans-serif font.

Proceedings of the 13th Annual Symposium on Precision Agriculture in Australasia

University of New England
Armidale NSW Australia
10-11th September 2009

Precision Agriculture Research Group



Group Members

Mr. Craig Birchall
Agronomy and Soil Science UNE
Mr. Ron Bradbury
Physics and Electronics UNE
Ms Emma Garraway
CRC for Spatial Information
Ms Susanna Greig
*Primary Industry Centre for Science
Education UNE*
Dr. Chris Guppy
Agronomy and Soil Science UNE
Associate Professor Geoff Hinch
Animal Science UNE
Dr. Paul Kwan
Computing Science UNE
Associate Professor David Lamb
Physics and Electronics UNE
Associate Professor Patrick Lenders
Computing Science UNE
Dr. Peter Lockwood,
Agronomy and Soil Science UNE
Mr Derek Schneider
CRC for Spatial Information
Dr. Mark Trotter
CRC for Spatial Information

Affiliated Post-graduate Students

Phoebe Barnes
Agronomy and Soil Science UNE
Peter Clark
Physics and Electronics UNE
Mr Paul Coop
CRC for Irrigation Futures
Brooke Sauer
*Cotton Catchment and Communities
CRC*
Mr Michael Schaefer
Physics and Electronics UNE
Lee Taylor
Animal Science UNE
Michael Whelan
CRC for Sheep Industry Innovation

✓ sensible agriculture

parg@une.edu.au
www.une.edu.au/parg

UNE
UNIVERSITY OF
NEW ENGLAND

Proceedings of the 13th Symposium on Precision Agriculture in Australasia

University of New England
Armidale NSW Australia
10-11th September 2009

ISBN 978-1-921597-11-4

Edited by:

M.G. Trotter, E.B. Garraway and D.W. Lamb.

Published by:

University of New England, Armidale, Australia.

Printed:

August 2009.

Example Citation:

Donald, D.D. and Daffy, D.D. (2009) "GPS-enabled duck plucking". In: Proceedings of the 13th Symposium on Precision Agriculture in Australasia. M.G. Trotter, E.B. Garraway and D.W. Lamb (Editors), University of New England: Australia, 103 pages.

The 13th Annual Symposium on Precision Agriculture in Australasia is supported by



www.crcsi2.com.au

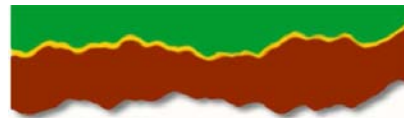

Australian Centre for Precision Agriculture

www.usyd.edu.au/agric/acpa



**Grains Research &
Development Corporation**

www.grdc.com.au



www.spaa.com.au



www.ecoaus.com.au



GEOSYS[®]

Decide your agriculture with confidence

www.geosys.com



www.cropoptics.com.au



www.fugrospatial.com.au



www.lreye.com.au



www.une.edu.au/parg



www.intspec.com

Foreword

Welcome to the 13th Symposium on Precision Agriculture in Australasia and welcome to the New England region and the University of New England (UNE)! The university prides itself on its regional and global impact and, with a long history of education and research in rural and environmental science, is particularly proud to host this symposium. Who says 13 is an unlucky number?

The considerable interest shown in this symposium from across the country has resulted in an expanded programme that includes poster sessions and two interactive half-day workshops (Precision Agriculture Technologies and GPS Livestock Tracking), as well as the usual plenary session led by two international keynote speakers.

Recent consultancy reports still put the adoption of precision agriculture (PA) in Australia at under 20%, despite overwhelming economic evidence of the benefits. The grains industry continues to lead in the adoption of PA, with help from its old friend viticulture, but there is growing interest and activity in the vegetable and livestock sectors. As well as showcasing some of the latest ideas in the cropping industry, this year's Symposium reflects the growth of interest in PA in some of these other sectors.

But there is more. Land management includes both public and private lands, and PA has a major role to play in issues of soil health and land-use from the perspective of biomass and carbon. It is not surprising that our state land management agencies are taking more interest in what PA has to offer. A recent successful bid to extend the CRC for Spatial Information (CRCSI) for another 8 years (\$32.2M, 2010-2018) was built, in part, on the Commonwealth and CRC partners recognising the value of PA in this context. This CRC will provide a much-needed boost to addressing major national issues like the need for networked CORS (continuously operating reference stations) and sustainable *farmscapes*. PA will feature strongly in *Biomass Business*, a large demonstrator program within the CRC. Biomass Business aims to develop spatial-based tools to drive on-farm improvements in water, fertiliser and pasture utilisation; improvements necessary to maintain and improve the profitability and sustainability of agricultural businesses, while maximising the synergies between production and environmental accountability. Providers of PA tools and services will also benefit from this long-term investment in R&D. The year of our 13th Symposium is indeed a lucky one.

Enjoy !

UNE-PARG Conference team.

Program

Thursday 10th September

Precision Agriculture Tools Demonstration and Workshop (PARG Demonstration Site, UNE)

- 9:00am Precision agriculture tools presentations
10:00am Open demonstration and discussion session
11:30am Lunch (provided)

13th Annual Symposium on Precision Agriculture in Australasia (Education building UNE)

- 12:00pm Registration opens (Foyer of Education Building)
- 2:00pm Official opening
Professor Alan Pettigrew (Vice Chancellor UNE)
Chair: David Lamb
- 2:10pm Managing nitrogen with active sensors
Jim Schepers (USDA - Agricultural Research Service)
- 2:40pm Canopy-scale detection of nitrogen in wheat using the Canopy Chlorophyll Content Index
Glenn Fitzgerald (Department of Primary Industries Victoria)
- 3:00pm Optimising nitrogen use in cereal crops using site-specific management classes and crop reflectance sensors
James Austin (Australian Centre for Precision Agriculture, University of Sydney)
- 3:20pm Evaluating a new proximal sensor for winegrape quality
Rob Bramley (CSIRO Sustainable Ecosystems and Food Futures Flagship)
- 3:40pm Afternoon Tea and Poster Session
Chair: Rob Bramley
- 4:20pm A producer perspective on the application of precision technologies
Kym I'Anson (South Australian grain and hay producer)
- 4:40pm RTK CORS networks – the future of agricultural machine guidance
Tim Neale (FARMpos Pty Ltd)
- 5:00pm Linking unmanned aerial vehicle (UAV) technology with precision agriculture
Leasie Felderhof (SkyView Solutions Pty Ltd)
- 5:20pm Measuring and mapping crop vigour using an active optical sensor in an ultra low-level aircraft
David Lamb (CRC for Spatial Information and Precision Agriculture Research Group UNE)
- 7.00 for 7:30pm
Symposium Dinner (Wicklow Hotel)

Friday 11th September

13th Annual Symposium on Precision Agriculture in Australasia (continued)

Chair: Ian Yule

- 8:30am Precision nutrient management in China supported by remote sensing and information technology
Ke Wang (Institute of Agricultural Remote Sensing & Information Technology, Zhejiang University)
- 9:00am On-farm carbon and biodiversity: mechanisms and PA tools for the future
Paul Frazier (Eco Logical Australia)
- 9:20am Autonomous tracking and control of livestock in extensive grazing systems
David Swain (CSIRO Livestock Industries)
- 9:40am Water use efficiency indicators for variable rate irrigation of variable soils
Carolyn Hedley (Landcare Research, Massey University)
- 10:00am Ord Irrigation Area - a diversity of precision agriculture applications
Jon Medway (Terrabyte Services)
- 10:20am Morning tea and Poster Session 2
Chair: Brett Whelan
- 11:00am Producer perspectives of precision agriculture
Richard Heath (Grains Producer and GRDC Northern Panel member)
- 11:20am A survey of Western Australian farmers on the uptake of precision agriculture: problems, issues and a way forward
Roger Mandel (Curtin University of Technology)
- 11:40am Examining the temporal availability of feed and regional turn-off patterns of cattle in Eastern Australia
Graham Donald (CSIRO Livestock Industries)
- 12:00pm Integration of operational constraints into management zone delineation methods
Pierre Roudier (Australian Centre for Precision Agriculture, University of Sydney)
- 12:20pm SPAA Producer Groups update
Mark Branson (Southern Precision Agriculture Association)
- 12:40pm Symposium Summary and Close
David Lamb (CRC for Spatial Information and Precision Agriculture Research Group UNE)
- 1:00pm Lunch

Friday 11th September (continued)

GPS Livestock Tracking Workshop (Education building UNE)

- 2:15pm GPS livestock tracking
Mark Trotter (CRC for Spatial Information and Precision Agriculture Research Group UNE)
- 2:30pm Pasture utilisation and nutrient redistribution in intensively managed dairy system
Ina Draganova (Institute of Natural Resources, Massey University, New Zealand)
- 2:45pm Adaptation behaviour of cattle relocated from the rangelands to a temperate agricultural grazing system
Dean Thomas (CSIRO Livestock Industries)
- 3:00pm Sirion, the new generation in global satellite communications: livestock GPS tracking & traceback
Gill Stassen (PacRim Satellite Communications)
- 3:15pm Afternoon tea and discussion session
- 4:30pm Close

Table of Contents

Foreword	i
Program	ii
Table of Contents.....	v
Speaker papers and abstracts.....	1
Managing nitrogen with active sensors.....	2
Canopy-scale detection of nitrogen in wheat using the Canopy Chlorophyll Content Index	11
Optimizing nitrogen use in cereal crops using site-specific management classes and crop reflectance sensors	12
Evaluating a new proximal sensor for winegrape quality	18
A producer perspective on the application of precision technologies	19
RTK CORS networks – the future of agricultural machine guidance	25
Linking unmanned aerial vehicle (UAV) technology with precision agriculture	30
Measuring and mapping crop vigour using an active optical sensor in an ultra low-level aircraft	31
Precise nutrient management in China supported by remote sensing and information technology	41
On-farm carbon and biodiversity: mechanisms and Precision Agriculture tools for the future	42
Autonomous tracking and control of livestock in extensive grazing systems	43
Water use efficiency indicators for variable rate irrigation of variable soils.....	44
Ord Irrigation Area – a diversity of precision agriculture applications	47
Producer Perspectives of Precision Agriculture.....	48
A survey of Western Australian farmers on the uptake of precision agriculture: problems, issues and a way forward	49
Examining the temporal availability of feed and regional turn-off patterns of cattle in Eastern Australia	50
Integration of operational constraints into management zone delineation methods.....	56
SPAA Producer Groups Update	61
GPS livestock tracking workshop papers & abstracts.....	63
GPS livestock tracking: an opportunity for a coordinated approach to research, development and extension	64
Pasture utilisation and nutrient redistribution in intensively managed dairy systems.....	65
Adaptation behaviour of cattle relocated from the rangelands to a temperate agricultural grazing system.....	66
Sirion, the new generation in global satellite communications: livestock GPS tracking and traceback.....	68
Poster abstracts	71
Advances in pragmatic survey of groundwater location and connection with surface waterways	72

Taking the guess work out of feeding cows	73
GPS-tracking livestock protection animals to improve wild dog management outcomes	74
Is pasture really less under the tree? Using an Active Optical Sensor (AOS) to measure changes in pasture around trees in grazing landscapes.....	75
Where are the roots? Can we deduce the edge of a tree's root zone without seeing it?	76
GPS livestock tracking in wetlands	77
A precision agriculture approach to targeted surveillance for grapevine phylloxera in vineyards.....	78
Integrating spatial data and farmer knowledge to identify causes of spatial variability in grain yield to change management practices.....	79
Preliminary approaches for determining regional scale variability of subsoil constraints in northern grains region	81
Monitoring N deficiency, stripe rust infection and yield in wheat using NDVI	82
Vegetation indices for the assessment and discrimination of rust infection and nitrogen deficiency in wheat leaves.....	83
Soil strength ... a useful parameter for mapping management zones.....	84
Varirate - an add-in for Arcpad to implement variable rate applications	85
PA tools and soil carbon inventories of farmscapes	86
Precision Management of Merino Sheep	87
PICSE – Exciting and encouraging the next generation of skilled agricultural scientists through Precision Agriculture.....	88
The development of a novel tracking system to investigate horse movement.....	89
Use of remote sensing to assess travelling effluent-irrigator performance on a dairy farm in New Zealand	90
Multi-temporal EMI survey of paddock-scale soil moisture variability	91
A new tool for measurement of spatial variability in vineyards.....	92
Design and demonstration of precision agriculture irrigation applied to different vegetable crops.....	93
Tactical nitrogen fertiliser for canopy management in wheat – implications for variable rate nitrogen applications.....	94
Spectral reflectance for the detection of grapevine leafroll-associated virus-3 in white-berried wine grape cultivars	95
Practical remote sensing applications for the peanut, sugar cane and cotton farming systems	96
Matching inputs to soil variations in cotton farming systems: how far can we push precision agriculture to deliver?.....	97
A simple field calibration procedure for EM38 units when undertaking multi-temporal surveys	98
What can sheep teach us about shelter use?	99
Interrogation of GPS tracking data to determine spatial grazing preferences of livestock	100
Can inter-row sowing be used in continuous wheat systems to control crown rot and increase yield?.....	101

Use of hand-held and in-line near infrared spectroscopy unit for non-invasive fruit quality assessment..... 102

Issues around pasture quality and production measurement systems 103

Speaker papers and abstracts

Managing nitrogen with active sensors

J.S. Schepers and J.F. Shanahan

USDA-Agricultural Research Service,
279 Plant Sciences, Agronomy and Horticulture Department,
University of Nebraska, Lincoln, Nebraska 68583-0934, USA

Corresponding Author: jim.schepers@ars.usda.gov

Abstract

Active crop canopy sensors are among the recent and most promising precision agriculture tools. This is because they overcome many of the limitations associated with passive sensors and conventional aircraft and satellite imagery. As with any remote sensing data, the challenge is to extract the meaningful information and render an interpretation that can lead to better informed management decisions. The reality is that management decisions need to be tailored to the soils, climate, crops, and cultural practices. Since soils cause most of the spatial variability in crop growth, it is appropriate to use soil information to the extent possible when interpreting remote sensing data. However, this approach needs to be contingent upon other “gate-limiting” factors like having adequate water to support the yield potential of the cropping system. Water is frequently limiting in many cropping systems at some time during the growing season and thereby dictates the crops that are grown and influences the related cultural practices. As such, remote sensing tools need to be developed in full recognition that any and all indicators of crop vigor are likely to be confounded by one another. The redeeming consideration is that all factors that affect plant growth are integrated within the photosynthetic process and manifested in terms of primary productivity. In so many words, this explains why plant chlorophyll content is highly correlated with crop yield and can be estimated by measuring canopy chlorophyll concentration (analogous to the potential speed per unit area of the factory) and the amount of living plant biomass (size of the factory).

Fortunately, visible light reflectance is indicative of canopy chlorophyll concentration and near infrared (NIR) reflectance is sensitive to the amount of living biomass in the canopy. When selectively combined to form a vegetation index, these two portions of the spectrum represent canopy chlorophyll content, which is highly correlated with crop yield as long as water is adequate. Red-edge reflectance represents a portion of the spectrum between the visible and NIR portions that is also sensitive to canopy chlorophyll concentration. The merit of having access to data from three waveband groups (visible, red-edge, and NIR) is that it can help differentiate between apparent nitrogen (N) stress and water stress. Both N and water stress can reduce the amount of canopy vegetation, but water stress is much more dynamic than changes in leaf chlorophyll concentration that occur over days or weeks instead of minutes or hours as with plant water status. The weakest link constraining adoption of this technology is the adequacy of an algorithm(s) that integrates soil and crop sensor information on a real-time basis. This need is confounded by environments and cropping systems where water is limiting or unpredictable at best. Yet, three-band active sensors have the potential to function within these constraints and software under development will enable the integration of crop sensor data with pertinent soil information when guided by individuals with knowledge of the local cropping systems. A Crop Circle three-band ACS-470 sensor was used to assess the spatial variability in the N status of corn and to make real-time fertilizer N applications.

Introduction

Production agriculture is a never ending challenge, but farmers and ranchers have learned to expect nothing less. When it comes to new technologies, agriculture has been the recipient of some unique spin-offs from military applications. In particular, access to global positioning systems (GPS) has opened the door to generating all kinds of maps. The natural application for these maps has been to use the information to make spatial and temporal management decisions. Nitrogen (N) fertilizer is one of the most costly inputs for grain producers. Determining the appropriate rate of N

fertilizer application is complicated because of natural processes that transform organic matter into plant-available forms and others that result in N losses from the soil (nitrate leaching and denitrification). Sensing the crop for its N status is a unique and evolving approach to improve nitrogen use efficiency (NUE).

Crop canopy sensors can provide information about leaf chlorophyll concentration and the quantity of plant material involved in photosynthesis. As a first approximation, measuring leaf chlorophyll concentration is considered a good proxy for assessing plant N status, which is expressed as leaf greenness to humans. Thus, the practical linkage is to measure leaf chlorophyll content with canopy sensors to estimate crop N status and in turn use the information to make N management decisions. Pertinent needs relate to the calibration of crop sensors and translating the data into a management decision that increases profitability. Specifically, the concerns and questions are:

- How to calibrate and interpret crop sensor data;
- Techniques to quickly and systematically characterize healthy plants in a field; and,
- Translating sensor data into a fertilizer application rate.

The concept of using the crop as a biological indicator of nutrient status was rapidly elevated to a high level of reality by the introduction of the Minolta chlorophyll meter (SPAD) in 1990. These hand-held devices proved to be an excellent research tool but were not practical for large-scale field monitoring applications. This limitation led to the development of passive reflectance sensors that could be mounted on high-clearance vehicles and used to control variable-rate nutrient applications. Problems with cloud cover and plant-to-plant shadows, coupled with the need for adequate sunlight limited the use of passive sensors to daylight hours. Research to develop active sensors was initiated in the late 1990s with the goal to overcome the monitoring limitations imposed by passive sensors. Now that at least three sources of active sensors for making variable-rate in-season nutrient applications have been commercialized, it opens the door to the next generation of sophistication. In a general sense, these new technologies will likely take the form of information management systems and extend to development of decision aids.

Sensor Calibration

The introduction of the Minolta SPAD meter for rapidly monitoring leaf chlorophyll status brought the need for calibration techniques. This need evolved because leaf chlorophyll content is influenced by cultivar selection, plant growth stage, leaf position on the plant, and cropping history. It would be an endless task to develop and maintain calibration relationships considering all of these factors. The concept of using an adequately fertilized part of the field as a reference or target was developed to translate sensor data into relative values that could be compared with other kinds of data such as yield. It is important to note that this normalization procedure was developed to aid in the analysis and interpretation of small plot data where spatial variability in soil properties was intentionally minimized within a replication. It follows that the reference crop idea works best when all production factors except the treatment variable (e.g., N fertilizer rate) are the same across the area being evaluated. Extending this concept to field strips can be problematic when it comes to making management decisions because crop sensor values are likely to be variable even though the entire strip is considered to have adequate or slightly excessive N availability. Never-the-less, referencing the crop at various locations to the most vigorous crop in the strip or field has tremendous comparative value when it comes to making management decisions. The value generated from such a comparison can be termed a sufficiency index (SI) (calculated as the value from the selected area under consideration divided by the value for the reference area). In the case of N rate studies on corn, the highest N rate is frequently used as the reference because a little excess N availability usually does not reduce yield. The example in Table 1 shows the SI values for eight replications where preplant N rates applied to irrigated corn ranged from zero to 200 kg N/ha. Each plot was 16-m long and 8-m wide arranged in two strips that were 400-m long.

Table 1. Sufficiency index values for irrigated corn at the 9-leaf growth stage determined using the Holland Scientific ACS-470 sensor to calculate the red-edge chlorophyll index.

Rep	N Rates (kg/ha)				
	0	50	100	150	200
1	0.64	0.83	0.90	1.00	1.00
2	0.62	0.77	0.89	0.90	1.00
3	0.59	0.82	0.90	0.98	1.00
4	0.57	0.82	1.01	0.92	1.00
5	0.73	0.84	0.91	0.95	1.00
6	0.63	0.85	0.95	0.89	1.00
7	0.63	0.84	0.88	0.99	1.00
8	0.59	0.71	0.90	0.92	1.00
Mean	0.63	0.81	0.92	0.94	1.00
CV (%)	7.9	5.8	4.6	4.6	0.0

Note that the most vigorous plots (SI > 1.0) for two replications of the 2009 data above occurred with less than the 200 kg N/ha rate. However, in general, the SI values show that the sensor was able to adequately characterize the vigor and N status of the crop (Figure 1). The optimum N rate for this long term study (1991-2008) is ~200 kg N/ha.

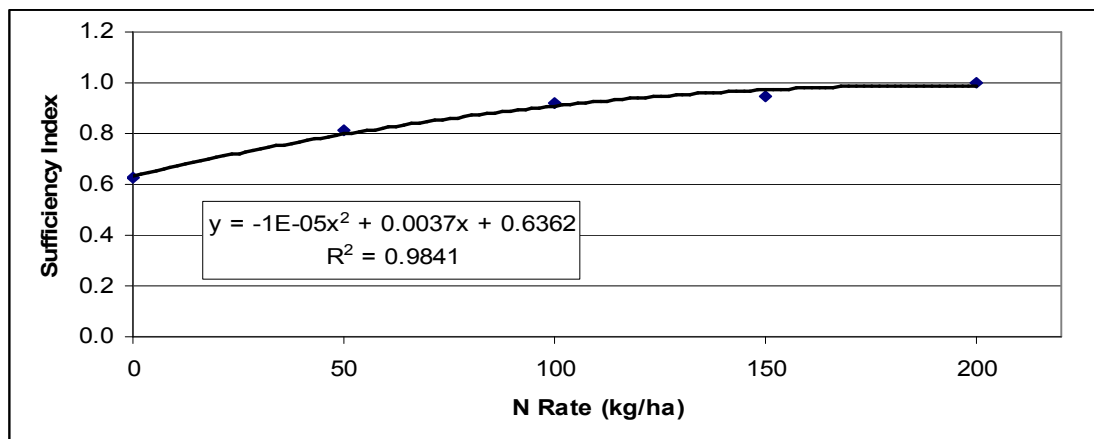

Figure 1. Effect of preplant fertilizer N rate on the sufficiency index for irrigated corn determined using on the red-edge chlorophyll index values acquired with the ACS-470 sensor at the V9 growth stage in 2009 (data from Table 1).

Identifying Healthy Plants

Researchers have proposed and evaluated various ways to determine the vegetation index of “reference” plants. Extending the SI concept that works well for plot studies to the field scale might include a few strips with a little excess N fertilizer. But there is sure to be some variability in sensor reflectance data throughout the strip even though the crop has access to adequate N. Uncertainties abound in terms of deciding which vegetation index values within the strip should be used as the reference for the rest of the field. Considering that sensor readings that are used to make in-season N recommendations for corn are usually taken between the seven (V7) and 14-leaf growth stages, it follows that it may not be necessary to establish an N-rich strip because a modest preplant N application is likely to provide more than adequate N at the time of sensing. For example, at the V7 growth stage of corn grown in the Corn Belt of the U.S., the crop has only taken up ~15% of its total N that will be in the crop at harvest. This amounts to <25 kg N/ha, so it is easy to see that

establishing an N-rich strip that amounts to the maximum rate that producers would consider applying is an over-kill. In some cases, excess early-season N has been shown to be detrimental to the crop, so in fact a more modest rate of early season N would be preferable. All fields and situations are bound to be different, but comparison of the vegetation index values for three preplant N application scenarios illustrates some of the concerns (Figure 2). The scenarios are:

1. The replicated N rate plots in one of the strips above (basically a randomized ramped strip with four replications);
2. Field strip that received 150 kg N/ha near planting time; and,
3. Field strip that received 50 kg N/ha near planting time. The previous crop was soybean where the 50 kg N/ha base treatment was applied and corn for the other two strips.

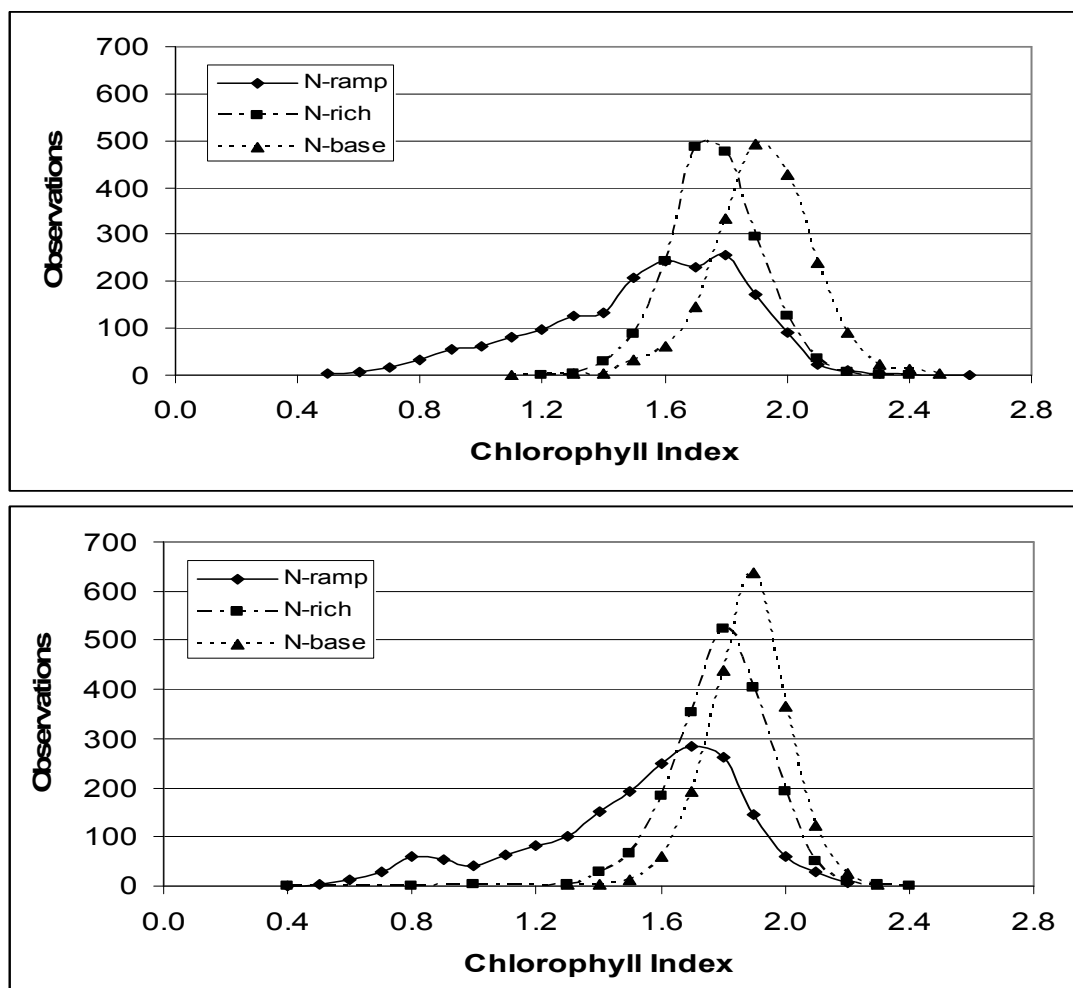

Figure 2. Histogram of red-edge chlorophyll index values (~1800 for each strip) for 400-m long field strips of irrigated continuous corn that included a series of replicated N rate plots (N-ramp).

The other two strips were alternated between corn and soybeans between 1991 and 2008. The N-rich strip followed corn and received 150 kg N/ha in 2009 while the N-base strip followed soybeans and received 50 kg N/ha. The upper and lower figures represent Pioneer brand P33D83 and P33D14, respectively. Data were collected at the V9 growth stage (14 July, 2009) from two rows using Crop Circle ACS-470 sensors with a 5 Hz sampling rate at ~6 kmph to match the GPS data stream.

Points to note are that the previous soybean crop significantly skewed the data to higher chlorophyll index values (N-base) even though only a modest rate of N fertilizer was applied at planting. Even though the strips that received the 150 kg N/ha rate at planting (N-rich) had been in

corn the previous year, prior to that they had been in a corn/soybean rotation between 1991 and 2007. The N-ramp strip has been in continuous corn with the same N rate imposed on the same plots since 1991. These data illustrate the importance of cropping history when interpreting crop sensor data and selecting a reference value. Never-the-less, it should be possible to develop a scheme to use the information contained within a histogram (data from one or two passes through the field) to establish a reference or target value for the field. Caution should be taken when field strips include soil types with drastic or even moderate differences in yield potential.

Fertilizer Recommendations / Algorithm Concepts

Synchronizing crop N needs with soil N availability offers the possibility to increase N use efficiency. The science required to make sound in-season N management decisions requires information about crop growth and vigor at the time of application and an appreciation for potential soil N availability during the remainder of the growing season. Present in-season N fertilizer recommendation algorithms for corn can generally be grouped into three approaches:

1. Minimum / Maximum Fertilizer Preference;
2. Normalized Growth Response; and,
3. Potential Yield Estimation.

All three involve the premise that crop vigor (chlorophyll status and amount of living vegetation or biomass) during vegetative growth stages will be proportional to yield at harvest. As such, stressed plants are expected to have lower yields than those that have an adequate supply of N throughout the growing season if no additional N fertilizer is supplied to correct the deficiency. Assessing in-season crop vigor embodies the premise that N supplied to the crop via mineralization prior to the time of measurement will be similarly enhanced for the remainder of the growing season. Each approach is uniquely different in their complexity and how they integrate pertinent soil processes, climatic considerations, and plant growth parameters into the resultant fertilizer N recommendation. Yet, each starts with the same in-season assessment of the crop based on active sensor measurements of reflected visible and near infrared light. The wave-bands used in the measurements do not necessarily have a bearing on the approach.

Minimum / Maximum Fertilizer Preference:

This approach is the simplest to implement because it involves the least amount of technical information and integrates the largest amount of intuitive information that would typically be supplied by producers. In the simplest sense, the producer indicates how much N fertilizer they would apply to a distinctly N deficient part of the field. Crop sensor readings are then taken from the area. In a similar manner, sensor readings are taken from an area of the field that has high relative vigor. Again, producers indicate the amount of N fertilizer they would apply to the vigorous crop. The N application algorithm is simply a linear relationship with increasing N rate as the degree of stress increases as determined with the crop sensor. This approach is used in Europe by some producers employing the Yara sensor to determine variable rate N applications to wheat and other small grains.

Scientists in Missouri developed a version of this approach for corn at the V6–V7 (knee to waist high) or the V8-V10 (waist to shoulder high) growth stages. This approach uses an “N-rich” area or field strip as a reference that is assumed to be non-N limited. The resultant algorithms are structured to recommend a base rate of fertilizer N regardless of the sensor derived vegetation index (67 or 56 kg/ha, respectively). Crop sensor data from other parts of the field are compared to the adequately fertilized area to calculate a sufficiency index. As the relative N deficiency increases the sufficiency index declines below 1.0 (“Happy Corn” = 1.0) and the N fertilizer recommendation increases. The upper limit of fertilizer N recommendation is set by the user and incorporated into the algorithm.

This approach makes no attempt to quantify N mineralization (biological conversion of organic N to mineral N as ammonium and nitrate) but rather embeds the process within the experiences of the producer or expert for the field or region. It assumes that the relative contribution of mineralization to the soil N pool is spatially similar before and after sensing the crop. This means that even though soil organic matter content varies spatially within a field, the

spatial distribution of mineralized N before sensing is assumed to be similar to the N mineralized between sensing and harvest.

The Missouri approach assumes that an N deficiency can be corrected by the addition of in-season N fertilizer applied at the V6 to V10 growth stages (i.e., yield potential of the field can be achieved by applying the recommended rate of in-season N fertilizer). Embedded within this assumption is the relationship between SI and relative yield if no additional N is applied (Figure 3). This relationship tends to be linear for modest levels of N stress, but under more stressful conditions no amount of additional N will restore the yield potential. A weakness of the Missouri approach is that it does not offer a back-off scheme to reduce the N rate for situations where the potential yield can not be achieved because of N stress or other factors (i.e., reduced plant vigor caused by drought, salinity, reduced population, etc.).

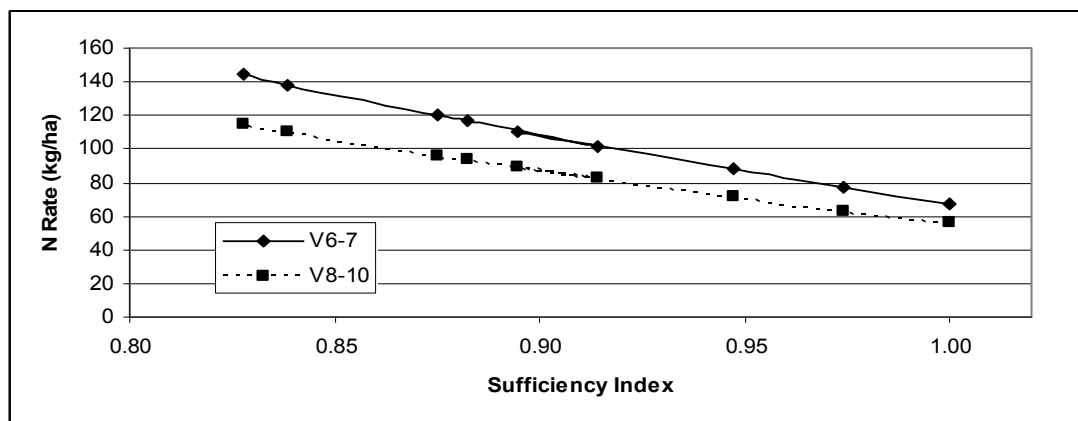

Figure 3. Relationship between the sensor-derived vegetation sufficiency index and recommended fertilizer N application rate using the minimum / maximum approach.

Normalized Growth Response:

This approach embodies the concept of relative yield in two ways. Relative yields are used because the in-season assessment of crop vigor is also a relative measurement and the assumption is made that factors influencing crop vigor prior to the in-season assessment will prevail until harvest. In essence, an in-season assessment that is relative to plants with adequate fertilizer N is expected to greatly reduce or eliminate concerns about differences between cultivars, the previous cropping history, and growth stage. It is most appropriate to note that environmental factors that are favorable for crop growth are also favorable for the biological processes (mineralization) in soil that generate inorganic N for plant uptake. For this reason, it is deemed unnecessary to try to compensate for the possibility of achieving higher than average grain yields.

The first embodiment is the relationship between fertilizer N rate and relative yield (Figure 4). Relative yield is used because it facilitates comparing data across years, cultivars, cropping systems, and cultural practices. As such, the unpredictable effect of climate on yield is removed which allows the less productive years to be compared to the more ideal years in terms of relative crop performance. Relative yield is calculated by dividing the yield for any location in the field by the yield from a representative area that is assumed to be non-N limiting, but with other plant growth considerations (e.g., tillage, hybrid, and other nutrients) comparable. The shape of this fertilizer N response function is probably most fully described by a quadratic-plateau model if N availability is quite excessive even though simpler models (linear-plateau or quadratic) may adequately describe the relationship for some data sets. The appropriateness of a model to fit the N response data (i.e., N rate versus yield) usually depends on the amount of available data for N rates beyond when yields reach a maximum (perhaps displays a plateau).

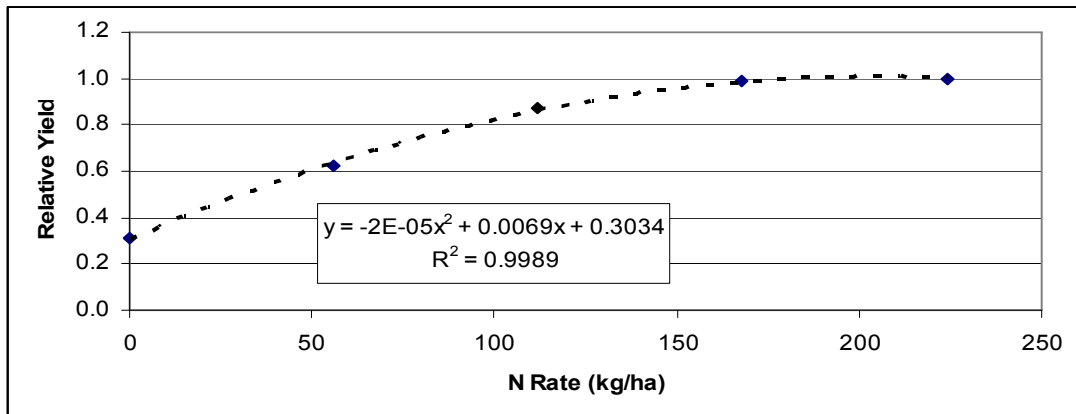

Figure 4. Typical relationship between fertilizer N rate and relative yield for corn.

The second embodiment is the relationship between the sensor-derived sufficiency index and relative yield (Figure 5). This relationship is basically linear for modest levels of N stress, but the slope changes somewhat with growth stage (see example below). For example, early in the growing season N stresses are likely to be relatively small compared to later in the season and so the range in sensor-derived sufficiency index values will be smaller for young plants than later in the growing season. As noted for the Minimum / Maximum Fertilizer Preference approach, the sufficiency index and relative yield values decline concurrently. Under more stressful conditions (low sufficiency index values), yield decreases proportionately more than the sufficiency index as noted by the data in the figure below (more appropriately described with a curvilinear function).

Neither form of the relative yield relationship (Figure 4 and 5) contains a back-off feature to accommodate highly stressed conditions (low sufficiency index conditions caused by severe N deficiency or other growth limiting factors) that reduce yield potential even though N is more than adequate for the remainder of the growing season. The sufficiency index versus relative yield relationship is relatively insensitive to cultivar differences because the effect is normalized out of the results during the calculation of relative yield (i.e., normalization involves calculating a ratio of yields to those from a non N-limited area for each hybrid). The in-season fertilizer N recommendation is generated by merging the N rate versus relative yield function and the sufficiency index versus relative yield function (relative yield in common to both relationships). The resultant function directly relates the sufficiency index calculated from the sensor data to the N rate recommendation needed to correct the N deficiency.

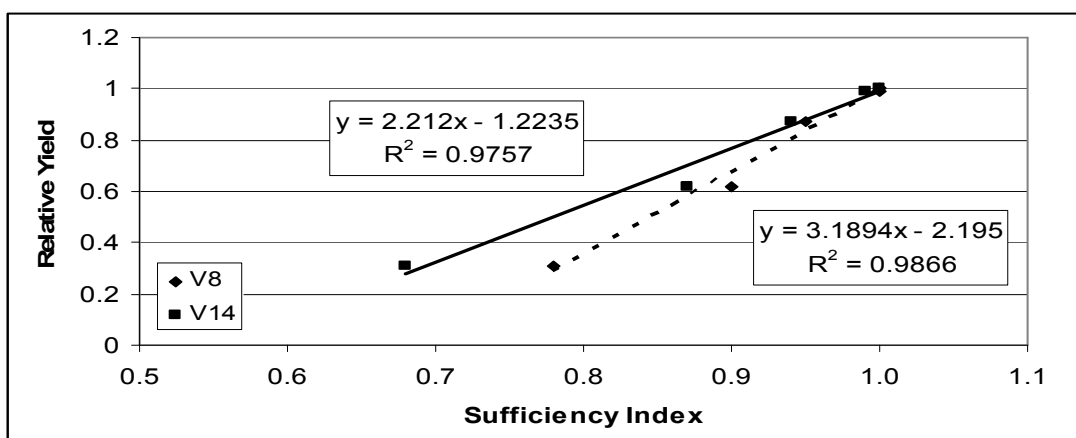

Figure 5. Relationship between sensor-derived sufficiency index and relative yield of corn at two growth stages (V8 and V14).

This approach assumes that N mineralization patterns within a field before sensing will be proportionately incorporated into the vegetation index values generated at the time of sensing and further that the spatial N contributions to the soil N pool before sensing will be indicative of those experienced later in the growing season. The efficiency of added fertilizer N is not directly incorporated into this approach because it changes considerably from year to year depending on climatic conditions and varies with the level of plant N stress. Both of these considerations are automatically incorporated in the N rate versus relative yield function.

It should be noted that the general shape of the N rate versus yield function is remarkably similar for corn, sorghum, and wheat. Situations with excess N availability are likely to indicate that crop yield did not respond to the added N fertilizer (i.e., data coincide to the plateau portion of a quadratic-plateau function). At the other extreme when N rates are not adequate to achieve maximum yield, the data would be expected to mimic the quadratic portion of the quadratic-plateau function. Basically, soil N supply shifts the function to the right or left (fertilizer N rate is represented on the X-axis) and year-to-year variability in yield shifts the function up and down. Normalizing the yield data removes much of the complexity when it comes to interpreting yield responses over time. Remaining issues like N mineralization and losses (i.e., denitrification and leaching) are difficult to predict with much accuracy so no attempt is made to quantify these considerations other than to recognize that they will be spatially variable and hopefully integrated into the crop vigor assessment at the time of sensing. In so many words, this approach does not seek to apply extra N to accommodate what might turn out to be a high yielding year. Rather, the approach assumes that favorable conditions for N mineralization compliment good growing conditions for the crop and thus there is no need to over-fertilize the crop just in case the last half of the growing season might turn out to produce high yields. The potential environmental implications are positive as is the potential for higher NUE values when extra N is not applied to support unusually high yields.

Potential Yield Estimation:

This approach was originally developed for making in-season N fertilizer recommendations for wheat in Oklahoma. The recommendation procedure is considerably more detailed than those previously discussed because it lets the user assign values to processes like fertilizer N use efficiency and grain protein content. It uses a few “Rules of Thumb” or guidelines like the relative proportion of grain to total above ground vegetation at harvest. The aspect of this approach that makes it uniquely different from others is that it uses the crop status at the time of sensing to predict potential yield for each part of the field. The potential yield prediction is based on historic plot yield data (N rate versus yield with early season sensor measurements) for the region. A key component of this approach is in knowing the number of growing degree days (GDD) between planting and sensing. For the most part, these data represent the growth rate before sensing. In so many words, this approach predicts yield potential using historic sensor-derived crop vigor data early in the growing season and related yield data from plot studies. For example, at the V8 growth stage of corn, the crop may have accumulated 500 GDD with a measured vegetation index value that generates a sensor-based sufficiency index value of 0.85 or so. Because Oklahoma State University scientists are using the “mass balance” approach to calculate the fertilizer N recommendation they need to generate a value for potential yield. This makes it possible to make some assumptions and calculate how much N will be required to reach the predicted potential yield. As such, they prefer to invert the sufficiency index value for the crop and call it a “Response Index” (i.e., a sufficiency index of 0.85 translates into a response index of 1.18). Response index data are basically used to extrapolate from the GDD at the time of in-season sensing to maturity (extrapolation from 500 GDD in this case to ~2500 GDD for corn in the Midwest). The reliability of any extrapolation naturally improves as the time remaining until harvest decreases, especially when climatic uncertainties are involved. For example, N uptake at the V9 growth stage in a Midwest corn crop with a 12-13 Mg/ha yield amounts to ~25% of the total above-ground N uptake being in the crop at harvest (~10% for biomass). Predictions based on measurements taken closer to harvest will involve less uncertainty. Many things can happen during that time, but irrigation considerably reduces the risk of significant water stress.

Scientists in Oklahoma recognize that their efforts to predict potential yield are based on historic plot yield records that are sure to include some years and situations with less than ideal growing conditions. Therefore, they increase the predicted yield by one standard deviation unit and call it “potential yield” for the reference area in the field. This amounts to using only the highest historic yields for a given level of crop vigor in the potential yield prediction. Once the potential yield is predicted, the approach assumes a typical grain protein content and harvest index (grain to total biomass ratio) value to calculate total N uptake. The difference between the estimated total N uptake at harvest for the N-rich area and the areas to receive fertilizer represents the amount of N uptake that is needed to achieve the same yield level as the N-rich area. The amount of needed N uptake is divided by a fertilizer use efficiency factor (perhaps 50 to 70%) to determine the fertilizer N recommendation. It should be obvious that the above approach is essentially a model because it quantifies each of the various processes and factors involved and thereby balances the mass of N in the system.

Algorithm Overview:

All three approaches for making in-season N recommendations face the same uncertainty problem because yield is the ultimate test of success and yet at the time of sensing another 70-90 days remain until harvest. Common concerns related to the reliability of each approach need to be evaluated for each cropping system, region (climate and soils), and producer’s confidence that the approach addresses pertinent considerations. Within the software programs to control the actual variable rate application of in-season N to corn are various thresholds and trigger points that alter the application rate strategy. For example, at some places in the field low vegetation index values may call for the N application rate to be reduced (cut-back feature) because it is deemed that the crop no longer has the potential to fully recover from the apparent stress or otherwise compensate in growth to achieve the full potential yield.

Canopy-scale detection of nitrogen in wheat using the Canopy Chlorophyll Content Index

G.J. Fitzgerald

Department of Primary Industries, 110 Natimuk Road, Horsham, Victoria, Australia

Corresponding Author: glenn.fitzgerald@dpi.vic.gov.au

Nitrogen (N) is one of the most expensive inputs for rainfed wheat systems in Australia. Targeting the right amount of nitrogen (N) at the right location and physiological stage could reduce or at least redistribute N inputs leading to improved N use efficiency on a field scale. This could reduce input costs and lower the risk of off-farm movement of N into water supplies or volatilised as greenhouse gases. Remote sensing offers the ability to detect canopy-level N status, providing for variable rate inputs. Currently, there are commercial providers offering sensors using the Normalised Difference Vegetation Index (NDVI) or related indices to assess canopy N status. Since NDVI is a measure of cover this approach is only valid if canopy N status and cover are correlated at critical times when additional N will be applied. In rainfed systems, where full canopy cover is rarely, if ever, realised, this may not apply. An index providing for a direct measure of canopy N would be preferable. Although there are various spectral indices for N detection reported in the scientific literature few, if any, have been shown to be effective at canopy scale detection consistently and robustly across either seasons or locations. Although hyperspectral approaches have been shown to be effective at detecting plant N, their cost and complexity preclude them from current operational deployment.

The Canopy Chlorophyll Content Index (CCCI) is a 3-band index that was developed to directly measure canopy N status and reduce the confounding effects of incomplete cover on the spectral signal. This index includes the two bands usually associated with the NDVI but also incorporates a third narrow waveband in the so-called 'red edge' portion of the spectrum, which has been shown to relate to changes in chlorophyll and plant N. A three-year (2004-2006) plot-level wheat experiment was set up with varying levels of N and water stress to provide a wide range of conditions for measuring wheat N status near Horsham, Victoria, Australia. A single relationship (calibration) was developed by normalising plant N by plant biomass and ground area to account for the N dilution effect caused by plant growth and changing N concentrations. Results showed that with ground-based spectral readings, the CCCI consistently predicted canopy N near stem elongation (DC 30-33) across the three years of data with $r^2 = 0.77$ and RMSE = 0.4 %N. Future research will endeavour to improve the ability of the index to detect stress and develop uniform calibrations across locations and seasons at the paddock scale. The use of active sensors will also be explored. These will further eliminate one of the obstacles to application of remote sensing technology, namely, variable lighting due to solar zenith angle and clouds.

Optimizing nitrogen use in cereal crops using site-specific management classes and crop reflectance sensors

J. Austin^A, B. Whelan^A and J. Hassall^B

^A Australian Centre for Precision Agriculture, The University of Sydney, NSW 2006, Australia

^B "Kiewa", Gilgandra, NSW 2827, Australia

Corresponding Author: b.whelan@usyd.edu.au

Abstract

The rising cost of nitrogenous fertilisers, along with the environmental implications of their waste, has lead crop producers to strive for greater synchrony between nitrogen (N) supply and crop N demand. Variable-rate management of inputs between identifiably different production management classes and in-season estimates of N requirements using crop reflectance sensors are being applied separately to achieve this goal. This preliminary study combines both techniques to improve the in-season estimates of N requirements by increasing the accuracy of in-season yield prediction functions through the inclusion of historic soil and yield information.

Experiments were conducted on two fields in north-west New South Wales, Australia using the Greenseeker® crop reflectance monitoring system. Stepwise linear regression was used to construct a range of field- and management-class specific yield prediction functions for each field from in-season NDVI, local yield calibration data and historical information (soil EC_a data, previous yield observations). The predictive ability of these functions was compared with standard functions employed by the Greenseeker® technology.

Results show that in the water limited conditions, variation in mean NDVI between potential management classes was identifiable. The development of modified class-specific yield prediction functions improved correlation between predicted and actual yields over the standard prediction

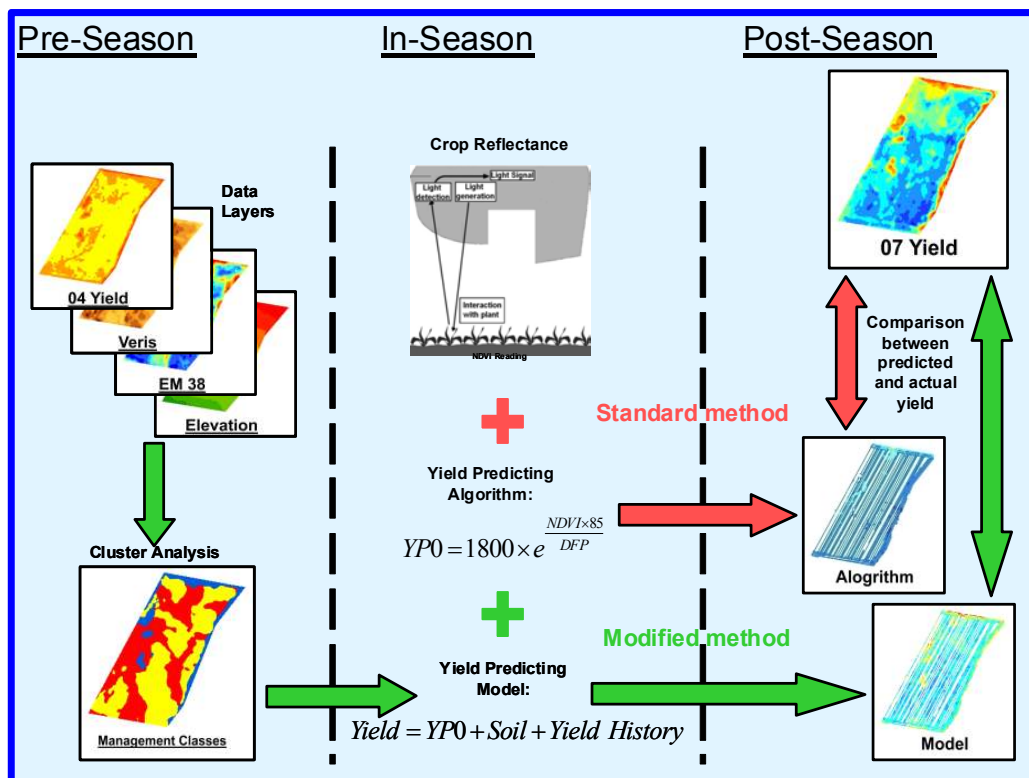

Figure 1. The concept

functions in both fields ($r = 0.39$ to 0.48 and $r = 0.22$ to 0.66). The localised calibration of the standard yield prediction function only improved correlations in one field, which is believed to be a result of water stress at the end of the growing season. The modified class-specific yield prediction functions were used with in-season NDVI measurements to construct N application strategies that proved more cost effective than the traditional pre-season applications. On average the projected savings were A\$44/ha. The combination of site-specific historic data and in-season reflectance information shows promise for the development of more efficient N application strategies.

The GreenSeeker method

The GreenSeeker aims to determine changing N application requirements in-season by using a process that compare the reflectance (calculated as NDVI) from unfertilised plants to those in a non-limiting N strip to gain a Response Index (RI). The process uses a series of generic functions (Equations 1 - 5) within region-specific algorithms. The regionality is achieved by local calibration of the functions providing different coefficient values (k).

The series of functions forming the N application algorithm include:

$$YP_0 = \text{MIN} \left[k_a \cdot e^{\left(\frac{NDVI \cdot k_b}{DFP} \right)}, \text{Max Yield} \right] \quad (1)$$

$$RI = \left(\frac{NDVI_{N \text{ Non Limited}}}{NDVI_{N \text{ Limited}}} \right) \quad (2)$$

$$RI_{adj} = \text{MIN} \left[k_c \left(\frac{NDVI_{N \text{ Non Limited}}}{NDVI_{N \text{ Limited}}} \right) - k_d, \text{Max } RI_{adj} \right] \quad (3)$$

$$YP_N = \text{MIN} \left[YP_0 \cdot RI_{adj}, \text{Max Yield} \right] \quad (4)$$

$$N_{\text{applied}} = \frac{P_N}{NUE} \cdot (YP_N - YP_0) \quad (5)$$

This process is prescribed for an environment where water is non-limiting, which is not the standard conditions in Australian dryland farming.

Modifying the yield prediction functions

The foundation of this, and all fertiliser rate decisions, is an estimate of expected/target crop yield. A number of GreenSeeker standard yield prediction functions are available to predict yield without fertiliser from the reflectance information.

For two fields in northern NSW, these standard yield prediction functions were compared with a local calibration (site-specific standard function) that was constructed by taking measurements on-farm. They were also compared with yield prediction functions that were made by adding in past yield and soil map data to try and include information about how the field has responded in the past (modified functions). These functions were also made for each management class (class-specific functions).

Improved yield prediction*Site-Specific YP 0*

The use of the $YP0_{KIEWA}$ function in predicting final yield presents a higher correlation with observed yield compared to the standard yield prediction functions currently used (Table 1).

Modified site-specific yield prediction functions

The development of modified site-specific yield prediction functions including soil EC_a data and previous yield observations further enhanced yield prediction accuracy. Significant increases in correlations across both fields and all classes indicate that the prediction accuracy of the modified functions is an improvement in yield prediction accuracy compared to the standard algorithms.

The higher correlation values and the lower AIC indicate that the modified three class site-specific function is the best yield predictor for both fields (Table 2). The improvement in yield prediction accuracy using the modified functions is further demonstrated by comparing actual yield maps (Figure 2) with those built using the standard spring wheat rainfed S.AU function and the modified three class site-specific functions for both fields (Figures 3 and 4).

Table 1. Correlations (r) of standard yield prediction function and modified site-specific yield prediction functions with 2007 yield, per field and per potential management class. NB Spring Wheat Rainfed S.AU is the standard prediction function used.

Field	Prediction Functions	3 Classes			2 Classes		Whole Field Uniform Function
		Class 1	Class 2	Class 3	Class 1	Class 2	
Diamond	<u>Spring Wheat Rainfed S.AU</u>	<u>0.50</u>	<u>0.31</u>	<u>0.25</u>	<u>0.40</u>	<u>0.35</u>	<u>0.39</u>
	Modified (S.AU)	0.52	0.34	0.27	0.42	0.37	0.40
	Site-Specific YP 0 ($YP0_{KIEWA}$)	0.55	0.35	0.31	0.45	0.40	0.43
	Modified ($YP0_{KIEWA}$)	0.57	0.38	0.32	0.47	0.41	0.44
	<i>Number of observations</i>	<i>13559</i>	<i>12846</i>	<i>8536</i>	<i>21198</i>	<i>13743</i>	<i>34941</i>
Mugs	<u>Spring Wheat Rainfed S.AU</u>	<u>0.15</u>	<u>0.001</u>	<u>0.15</u>	<u>0.14</u>	<u>0.16</u>	<u>0.22</u>
	Modified (S.AU)	0.31	0.49	0.38	0.40	0.62	0.49
	Site-Specific YP 0 ($YP0_{KIEWA}$)	0.18	0.17	0.16	0.19	0.27	0.24
	Modified ($YP0_{KIEWA}$)	0.32	0.50	0.38	0.40	0.63	0.49
	<i>Number of observations</i>	<i>11116</i>	<i>2826</i>	<i>13953</i>	<i>15821</i>	<i>12074</i>	<i>27895</i>

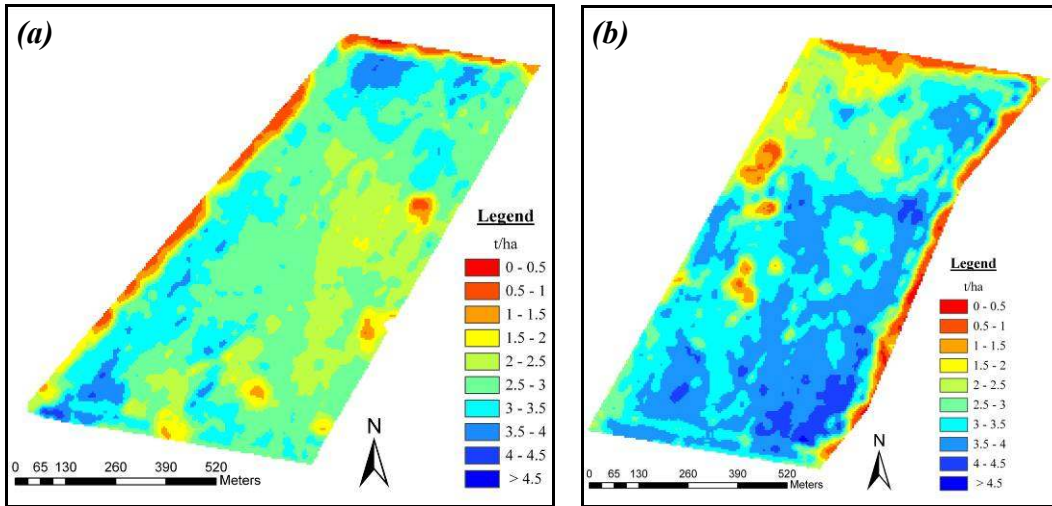

Figure 2. (a) 'Diamond' 2007 wheat yield map; (b) 'Mugs' 2007 wheat yield map.

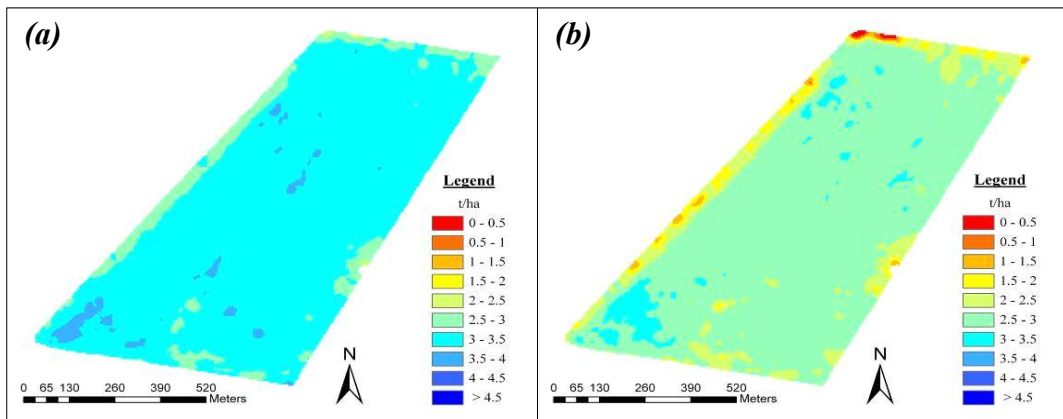

Figure 3. Interpolated maps of predicted potential grain yield with no fertiliser (YP 0) in 'Diamond' using: (a) Spring wheat rainfed S.AU function, (b) Modified 3 class-specific function (Site).

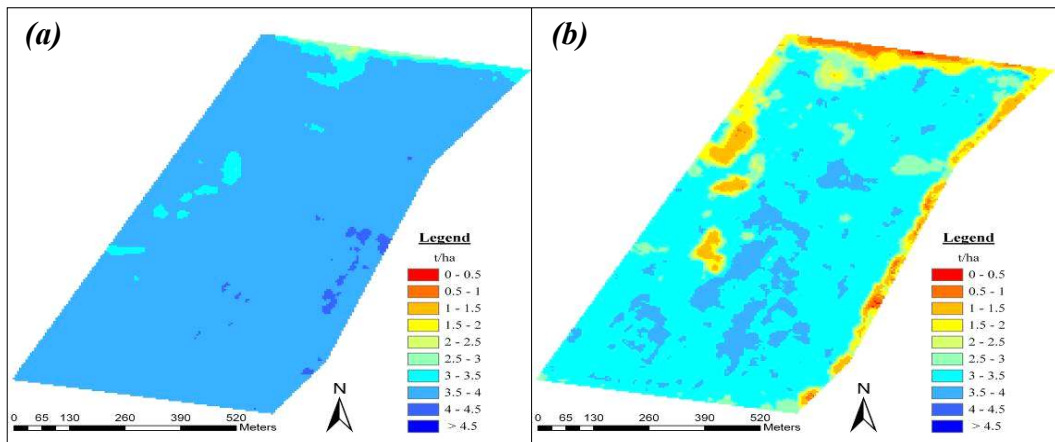

Figure 4. Interpolated maps of predicted potential grain yield with no fertiliser (YP 0) in 'Mugs' using: (a) Spring wheat rainfed S.AU function, (b) Modified 3 class-specific function (Site).

Table 2. Whole field correlations (r) and Akaike information criterion (AIC) of standard yield prediction function and modified site-specific yield prediction functions with 2007 yield, per field. Note: The whole field correlation for the class-specific functions was computed by recombining separate class predictions into a whole field.

Prediction Function	Whole field correlation (r)		Akaike information criterion (AIC)	
	Diamond	Mugs	Diamond	Mugs
Spring Wheat Rainfed S.AU	0.39	0.22	326210	274972
Site-Specific YP 0 (YP0 _{KIEWA})	0.43	0.24	324863	274722
Modified Uniform Function (S.AU)	0.40	0.49	325588	268522
Modified 2 Class-Specific Function (S.AU)	0.42	0.58	325068	264974
Modified 3 Class-Specific Function (S.AU)	0.43	0.66	324564	260133
Modified Uniform Function (Site)	0.44	0.49	324272	268639
Modified 2 Class-Specific Function (Site)	0.46	0.58	323362	264641
Modified 3 Class-Specific Function (Site)	0.48	0.66	322653	260013
<i>Number of observations</i>	<i>34941</i>	<i>34941</i>	<i>27895</i>	<i>27895</i>

Nitrogen Application

Financial Analysis

The predicted in-season application of N fertiliser in both fields cost less than the traditional method of adding N fertiliser pre-season (Table 3 and Table 4). In a season such as the 2007 season when moisture stress was evident and the RI from N fertiliser was low, minimal levels of N fertiliser are calculated as being required. If additional N fertiliser was to be applied in-season as per the spring wheat rainfed S.AU algorithm recommendations, total savings on N fertiliser compared to pre-season N application would range from \$2046–2060 in ‘Diamond’ (Table 3) and \$3 385 - \$3 399 in ‘Mugs’ (Table 4). This significant saving on fertiliser is furthermore increased through the use of the site-specific function or the modified site-specific functions. The improvement in the accuracy of yield prediction results in improvements in the targeting of N application and this results in total savings of up to \$2 535 in ‘Diamond’ (Table 3) and \$3 586 in ‘Mugs’ (Table 4) when using the modified three class functions.

For the 2007 season the average saving per ha across the fields studied on the farm was \$44 ha⁻¹. If savings of this magnitude were attained across 1000 ha this would equate to a saving of \$44 000 per season resulting in the capital expenses of the crop reflectance sensors being recovered in under one season. In addition to the direct savings seen from in-season N fertilisation there is the potential to minimise the loss of N to the environment by avoiding over-application. This aspect has less impact on management in Australia at present.

Conclusion

The functions were all made using a statistical process that ‘chose’ the most important data layers to add from those available. All the modified functions included previous crop yield where available. They also all included some measure of the soil EC_a data. The spatial variability in soil EC_a is strongly influenced by changes in soil texture and the effect on soil moisture holding capacity. The presence of soil EC_a in each modified function suggests that soil texture and soil moisture are major factors influencing the variability in yield. In all of the modified functions (24 in total), soil EC_a measured over the profile depth or from the ‘subsoil’ was included as a significant predictive parameter. This is not unexpected as in dryland cereal production throughout Australia subsoil moisture provides a major contribution to crop water supplies.

Table 3. Economic analysis of different N management strategies in Diamond. Assumes Urea is 46% N and costs \$800 t⁻¹

Management Practice	N Algorithm	Mean N (kg ha ⁻¹)	Total N (t)	Total Urea (t)	Cost/ha AUSS	Total Cost AUSS
Traditional	–	35.00	2.51	5.45	60.87	4,358.26
Uniform	Spring Wheat Rainfed S.AU	18.46	1.32	2.87	32.10	2,298.67
2 Classes	Spring Wheat Rainfed S.AU	18.54	1.33	2.89	32.24	2,308.63
3 Classes	Spring Wheat Rainfed S.AU	18.57	1.33	2.89	32.30	2,312.37
Uniform	Site-Specific YP 0	17.30	1.24	2.69	30.09	2,154.23
2 Classes	Site-Specific YP 0	17.44	1.25	2.71	30.33	2,171.66
3 Classes	Site-Specific YP 0	17.47	1.25	2.72	30.38	2,175.39
Uniform	Modified Uniform Function (Site)	14.50	1.04	2.26	25.22	1,805.57
2 Classes	Modified 2 Class Function (Site)	14.69	1.05	2.29	25.55	1,829.22
3 Classes	Modified 3 Class Function (Site)	14.64	1.05	2.28	25.46	1,823.00

Table 4. Economic analysis of different N management strategies in Mugs. Assumes Urea is 46% N and costs \$800 t⁻¹

Management Practice	N Algorithm	Mean N (kg ha ⁻¹)	Total N (t)	Total Urea (t)	Cost/ha AUSS	Total Cost AUSS
Traditional	–	35.00	2.40	5.22	60.87	4,175.65
Uniform	Spring Wheat Rainfed S.AU	6.51	0.45	0.97	11.32	776.67
2 Classes	Spring Wheat Rainfed S.AU	6.63	0.45	0.99	11.53	790.99
3 Classes	Spring Wheat Rainfed S.AU	6.58	0.45	0.98	11.44	785.02
Uniform	Site-Specific YP 0	6.14	0.42	0.92	10.68	732.53
2 Classes	Site-Specific YP 0	6.10	0.42	0.91	10.61	727.76
3 Classes	Site-Specific YP 0	5.93	0.41	0.88	10.31	707.47
Uniform	Modified Uniform Function (Site)	5.13	0.35	0.77	8.92	612.03
2 Classes	Modified 2 Class Function (Site)	5.01	0.34	0.75	8.71	597.71
3 Classes	Modified 3 Class Function (Site)	4.94	0.34	0.74	8.59	589.36

The creation of modified class-specific yield prediction functions using historic production information has been shown in this preliminary study to improve the in-season prediction of variation in yield potential, especially in water-limited environments. Further exploration of the concept across a range of environments is warranted to explore improvements in in-season N management.

Evaluating a new proximal sensor for winegrape quality

R. Bramley and J. Ouzman

^ACSIRO Sustainable Ecosystems and Food Futures Flagship,
PMB 2, Glen Osmond, SA 5064, Australia

Corresponding Author: Rob.Bramley@csiro.au

Recent research has demonstrated that vineyards are variable; that their patterns of variation in yield and vine vigour tend to be stable in time; and that patterns of variation in fruit quality tend to follow those for yield. However, whereas the low and high yielding zones will always be so (in the absence of intervention), the fruit quality ranking of these zones may vary from year to year. Thus, strategies such as selective harvesting have been dependent on targeted pre-season berry analysis which can be slow and expensive, and/or sensory assessment of fruit by time-challenged winemakers. Attempts have been made to derive quantitative predictive relationships between remotely sensed imagery and indices of the quality of winegrapes, but these have been insufficiently robust for predictive purposes and are also reliant on the aforementioned laboratory procedures. A key limitation to the adoption and on-going development of Precision Viticulture (PV) has therefore been the lack of a commercially available crop quality sensor.

Multiplex®¹ is a hand held multi-parameter optical sensor based on non-contact leaf or fruit autofluorescence. Insensitive to ambient light, and therefore of use both in the lab and outdoors, it records 12 signals (4 excitations x 3 emissions) from which signal ratios can be derived which relate to the contents of chlorophyll, flavanols and anthocyanins in the target. The latter two are of key interest in winegrape quality assessment.

Whilst the application of Multiplex® to winegrape monitoring has been promoted on the basis of its utility for monitoring the development of phenolic maturity in the fruit, and therefore the timing of harvest, we were interested in exploring its use for assessing within-vineyard spatial variation in indices of fruit quality. In particular, we wanted to see whether it offered improvement over previous efforts based on hand sampling and laboratory analysis, and whether it has potential (with modification) as an on-the-go sensor to be used in conjunction with grape yield monitors.

This presentation will describe work conducted during vintage 2009 in vineyards in the Eden Valley (Riesling), Padthaway (Shiraz) and in Coonawarra (2 x Cabernet Sauvignon) in which Multiplex® measurements were collected at sampling intensities ranging from 45-162 vines ha⁻¹. Each of the study sites had been used in previous PV research and so were vineyards for which we already had substantial information as to their spatial variability.

Initial results suggest that an instrument such as Multiplex® may assist in the delineation of fruit quality 'zones' within vineyards and therefore in the management of selective harvesting strategies, especially if deployed as an on-the-go sensor.

¹ The use of trade or other names does not imply endorsement by CSIRO

A producer perspective on the application of precision technologies

K. I'Anson

I'Anson Farms, RMD Saddleworth, SA 5413, Australia

Corresponding Author: iansonfarms@bigpond.com

Location



Facts

Rainfall:

- Areas within a 20km radius of home 250 to 325mm Growing Season Rainfall (GSR) average for last seven years.
- Long term average 425mm GSR.

Soil Type:

- Predominantly a red brown loam over heavy red clay, prone to acidity, sodicity, waterlogging and rye grass.
- Gray shale very shallow, prone to acidity, well drained.
- Black heavy clay, pH neutral, prone to compaction, sulfonylurea (SU) residues, broadleaf weeds.

Farming Career: 2000 to present.

Equipment:

Seeding

- John Deere JD 8430 FWA, Ausplow DBS 11m bar, 7000L Horwood Bagshaw trailed Quad cart, triple bin, Farmscan VRT electric drive, 2 m wheel spacing.

Spraying

- Goldacres 33m truck mount on 2m wheel spacing, Twin line AI Jets, One dosatron unit for adding a spike to knockdowns manual control.

Fertilising

- JD 7730 FWA, 2m wheel spacing, towing the Horwood aircart with a 33m air boom mounted on the cart.

Harvesting

- JD 9650 STS, APEX yield mapping, 4m wheel spacing.

Technology

- JD autosteer GS2600, SF2 beacon, Garmin GPS, Toughbook, Cropspec cameras, PAM Farmstar, Site Mate scouting program.

Key pointers to making precision technologies work

- Patience and an inner passion.
- Have a committed and driven team to push through the challenges of data capture and issues associated with processing, computer malfunction, loss of time and connectivity issues.
- Use variability as your key driver.
- Clearly identify your major constraints to production and put a dollar value on their loss. This will be your benefit if you fix the problem. Then you can select the most cost effective tool/s to address the problem/s.
- Have a thorough knowledge of your paddocks and a picture of how you expect the zones to be so you can easily ground truth the maps you create.

Introduction

I will give you a snapshot of where we are currently at in our business with these PA technologies. Some have come and gone but this selection is best suited to our soil types, rainfalls, personnel and the cropping operation and offers many opportunities for further application of the technology as time allows.

To apply these techniques you need the correct discipline. If you are a person who is innovative, you challenge yourself and you have a desire for perfection on your farm. That is the attitude you need to successfully use these technologies.

Our business

Our expectations are very high in all aspects of the cropping operation and that sums up why we farm. We are very driven and in the past our farm has experienced many very damaging problems. We suffered from acidity which led to large populations of ryegrass and crop competition in 30 % of paddock area, sodicity which caused large areas of waterlogging up to 50 % of the farm and some 10% is still suffering. This will be corrected now we have created a way to identify those areas, both of which combine to reduce yields by 70% in affected areas. Major problems arose resulting in low water use efficiency (WUE) and as such low profitability. At this point in time we were moving from conventional farming to no till. Our focus was designing a system to rip below the seed to drain some water away while still placing the seed at optimum depth so the two basic problems acidity and sodicity were not addressed. I also left to get an education in Armidale and I must have matured a bit as I decided to return home eventually and found we could embrace the limitations to our production by adopting and adapting precision technologies. We have a great asset in our land, the soil type is very good at retaining water and we do get some rain (250mm to 320mm GSR) depending where you are standing.

Our precision technologies in practice

First goal - fix soil constraints

Then we would have more confidence in soil nutrient availability we would also have an improved WUE of 20kg/mm to use in our yield estimates. (WUE in our soil type has improved from 7kg/mm, caution is needed as we have not experienced the extremely wet years of the past when this occurred but would assume our new farming methods would help). These changes would then enable us to have a reliable yield estimate based on availability of moisture to fertilise to.

From there we could utilise our yield maps to create VRT maps for phosphorous (P) replacement, and we could use optics such as CropSpec by Topcon to sense crops for NDVI to variably apply Nitrogen (N).

Second goal - precision application of inputs

Fertiliser is our key cost, accounting for 30% of our direct inputs. Chemicals and fuels both account for 15% each. Its cost spiralled as we moved to a high input system aiming for unrealistic yields not matched to available moisture.

With VRT the amount of P and N applied has been reduced to match production but these cost savings has been matched by price rises in fertiliser.

The averages over the total farm area are:

- 2006 - 100kg DAP / ha;
- 2007 - 80kg DAP/ ha;
- 2008 - 70kg DAP / ha; and,
- 2009 - 60kg DAP / ha, with VRT DAP rates are varying 20kg DAP/ ha to 120kg DAP / ha.

Urea has remained constant at 65kg Urea/ ha surprisingly for this period 2006 to 2009 but now with N sensing and VRT we are redistributing N from high N areas to low N areas so the N rates vary from 0kg Urea(46%)/ ha to 140kg Urea(46%)/ ha.

Soil amelioration

January 2000

- Lime

The problem of acidity was too large and expensive to rectify using blanket applications of lime so this began our first venture into PA. As we suspected the problem was variable. We went small budget \$500 iPAQ, borrowed a scouting program that allowed us to grid our paddocks so we could soil test in 1 to 4 ha zones determined by texture, colour, clay content and purchased a pH meter \$100. This project took 3 years to complete and lime and gypsum was spread over that period according to the maps.

pH varied from 4.2CaCl to 7.0CaCl in top 10cm, a large variation.

This method allowed us to spread the worst affected areas which were 30% of most paddock areas. It was a way to confront the issue and get maximum benefit from our expenditure. At the end of this 3 year period we began a program over a five year period to place a further application of lime on these lowest areas and then begin treating the next 30% of paddock area with an overall aim to get pH to a minimum of pH 5 in CaCl. Now our aim is pH 6 Ca Cl for the farm and this will be achieved by next year, two years ahead of schedule due to it being easier to raise pH from higher levels.

- Gypsum

Exchangable Sodium Percentage ESP varied from 0% to 15% in the top 10cm and became progressively higher as you moved deeper in the profile.

In our experience, sodicity has generally followed acidity. To check this we sent away representative samples to ground truth the zones. While we can match the high ESP areas to ones of low pH and we have treated those areas, we have not been able to clearly identify other sodic areas that become waterlogged and are not related to pH.

For the first time this year our biomass images taken at a particular growth stage (GS 14,22) have given us a perfect picture of waterlogging (sodic areas) in our paddocks and will allow us to recognise the remaining 10% of waterlogged areas. This growth stage is too early to get a good indication of N status in the paddock; however, it has given us a map we can use for gypsum application.

Summary

Is there an easier way to map pH and ESP? I hope so. I see acidity as a major limiting factor in crop production through both direct and indirect effects. Either way it affects crop growth which leads to poor competition and an explosion in weed numbers. All these factors result in lower

yields and reliance on chemicals for a period and the potential for development of chemical resistance.

A cost effective method needs to be commercialised to allow producers to begin addressing this problem. They can then better target their lime application to the areas most in need rather than wasteful blanket applications.

I can create these zones manually through my soil test points but I cannot produce a useable VR map as my test points are too few. It is this map I need to be able to feed into a VR spreader controller. This is one of our goals for the future.

Yield mapping

December 2002

- Yield mapping with JD using JD office

We had previously been using a yield monitor (which cost a fortune in 1999 at \$5 000) which was used to identify broad zones and evaluate trials. Not being linked to a GPS, it was only useful at that point in time but was an essential part of our PA learning.

The maps from 2002 to 2006 were not adequate for us to use to variably apply nutrients at seeding because of a range of issues showing up on the maps, e.g. frost, snails, slugs, waterlogging, ryegrass, excess N – haying off, N deficiency all of which were present on the maps and are problems we can fix. They are not underlying permanent problems of the soil type and as such to variably apply inputs across these zones would fail without a lot of work on the data which we could not do at the time. From 2007, 2008 our yield maps are becoming consistently related to soil type, elevation and aspect.

Guidance

April 2004

A relatively late start into guidance but we took delivery of some of the first JD autosteer units and adapted it to our tractor and used SF2 signal with 10cm accuracy. This was a well refined although basic autosteer unit. It was accurate and simple to use and was implemented easily. We have upgraded this over time with a new colour screen and a more powerful receiver to improve accuracy.

We were unhappy with trials of early sub metre guidance due to cost and three metre variation at times and used alternatives such as marker arms on the seeding equipment and spacing specific tynes on wheel tracks at 12 inches to mark tracks for our sprayer and fertiliser applicator.

- Controlled Traffic (CT)

Our soil has benefited from gypsum and deeper ripping up to 150mm below the seed. It is very compacted and prone to being recompacted so CT seemed a natural fit to fix our soil problems. While we have been using the same approximate tracks for some years now with autosteer it is now possible to implement partial CT as we can have permanent tracks that are repeatable every year. Our harvester is not in this system and cost will prevent it from being included as all of our equipment is designed around a 2 metre CT system and has been done at minimal cost with existing equipment.

April 2005

Inter row sowing. The next application of our autosteer. It was very successful and has enabled us to easily get through significant stubble loads. Stubble management is still a key factor especially with no livestock but the autosteer is the final tool we use to get through the stubble by keeping between the rows. Wet conditions will still cause problems but we work around the weather. Another benefit has been to achieve better plant establishment, reducing seed rates by 15% while still obtaining the same plants per m². Tall stubble 18 inches also encourages the crop to grow taller quickly compared to areas where stubble is low in height. This increases plant shading which should have an effect on competing weeds and their seed set for that year.

One further benefit is the standing stubble reduces soil throw enabling slightly faster sowing speed.

Nitrogen

July 2006

- N sensing

Our final issue of excess N in areas of the paddock had to be addressed to improve yields and save money in those areas.

I picked two paddocks that had zones of unlimited N and zones of deficiency. I did not know the boundaries of these zones but knew their general location. The first step was to locate a deep N test point in two areas. This testing showed the high area to have 200kg N while the low area 70 kg N. We scanned the paddocks in July at GS 31 and produced biomass maps for those paddocks. 20% of paddock needed no N, a further 30% needed a quarter of the prescribed rate, 20% needed half the rate, another 20% needed the full rate, and 10% needed more than full rate.

These were very exciting results that led us to do further scanning in subsequent years and now a suitable scanner has been developed for our situation. We have recently purchased a CropSpec scanner through Topcon.

The results in each paddock are the same for those initial paddocks which surprised me as I was unaware of such large variations in other paddocks due to biomass influenced by the N content of the plant.

To interpret the data is complex but we adopt simple rules. Our strategy is now to choose a target yield for an average season based on the last five years. This yield will vary according to seasonal moisture conditions and expected rainfall at any instance in the growing season.

Oats, Canola, Barley Strategy

We then work out a seeding N rate based on soil N levels to match this yield, then we reduce this seeding N rate by one third. The theory is that approximately one third of our paddock has excess N another third a normal amount and the next third a low amount of N.

Wheat Strategy

The wheat strategy is the same as above but much less N at seeding, as you have the ability to apply N to wheat at later growth stages to match expected yield and manage water use.

Then we scan our paddocks, produce a biomass map with six zones, ground truth the maps visually and, coupled with use of NIR analysis, fertilise accordingly. I am sure this strategy can be improved further but we see this biomass data as very important and need to use this data now in a way that our staff can understand and learn from.

Summary

Is this process working? Yes, the high areas do not need N. Even this strategy is giving too much N to those areas so we will cut back our seeding rates further. We need to be careful as the low areas do suffer from a lack of N and it is hard to find a balance. Hopefully with more maps we can better identify the low and high N areas but they do change depending on the season and also through our variable N program.

I would like to see more work in this area using NDVI or similar data to relate it to N content of the plant which can then be related to yield and, in turn, N application. For example, I want to produce a 4 tonne wheat crop and I have a reading of 0.7. This means from the recommendation I need to apply a further 35 units of N / ha. Then we can have more confidence in our N decision and we may then be confident to scan and spread in one pass, knowing we won't over apply N in areas that do not need it.

Phosphorous

July 2007

- VRT Phosphorous replacement

We began experimenting with this as time allowed. The key trigger to using VRT in 2006 was that 60 % of our farm was affected by frost and income was drastically reduced. It was known the P demands in these areas would be less and we should implement the technology which we already had. We use a farmscan VRT controller, really an unsupported piece of hardware but this is improving now, back then we did not have the program knowledge to create VRT maps.

My wife returned to work fulltime in our business and took on the role as precision data manager. Fairport, through PAM Farmstar, were a key help in our move to VRT and had redeveloped Farmstar, a mapping and data processing program at this time. Colin Booth at Fairport is continually working with us to improve their program and it has become our most powerful tool. It centralises our data, it is universal, can read all types of data and output data to any VR controller.

Weed mapping

April 2009

- Weed Sensing

A one-off opportunity presented itself in this season. Summer rains had pre-germinated all volunteers and the autumn germination was only rye grass. Over the last eight years we have controlled ryegrass down to series of patches totalling about 30% of affected paddocks. If we could identify these areas we could selectively target them with all of the tools available, mainly chemical (even if it was uneconomic) on small areas of the paddocks. The aim was to scan the selected paddocks with a Yarra N sensor which Sam Trengrove has experience with. Unfortunately, we were unfamiliar with the technology for this use and we did not get the desired results in a map. Reasons were maybe the wrong N sensor- lack of working time, wrong datalogger, inexperience, sowing in progress and lack of personnel.

Determined, we manually logged the areas. This was difficult so a hand drawn scale map was the end result. Logging of weed patches has been regularly used to mark small patches of new weeds but gets more difficult to define a boundary on a larger scale. We did spray the ryegrass patches and some extra. Chemicals included Boxer Gold (\$32/ha), Trifluralin (\$7/ha), Avadex (\$20/ha), Metalachlor (\$7/ha), at a total cost of \$66/ha on 30% area.

Summary

For southern regions, ryegrass is a major production issue. I think Sam Trengrove should be supported in his work and more work should be done on scanning technology to be able to create maps of weeds that we could variably apply chemicals to. Direct injection is a reality and as these ryegrass specific chemicals are applied 'incorporated by sowing' (IBS) with knockdowns we could get this technology to work and target these chemicals to selected areas while still applying our standard knockdowns over the paddock. All we need is a map - the same problem as pH maps and ESP maps.

RTK CORS networks – the future of agricultural machine guidance

T. Neale^A, A. Whitlock^A and G. Clark^B

^A FARMpos Pty Ltd

^B Leica Geosystems

Corresponding Author: tim@ctfsolutions.com.au

Abstract

The use of high accuracy Real Time Kinematic (RTK 2cm) GNSS (Global Navigational Satellite Systems) in agriculture is growing rapidly; with an estimated 4000 RTK units used in Australia for tractor auto-steer and Precision Agriculture (CTF Solutions, 2008). The high growth of RTK use has prompted users, GNSS companies, and governments to identify alternatives to single reference stations, as they are costly, independent, inefficient, and do not offer redundancy.

Surveyors have used CORS (Continuously Operating Reference Station) networks around capital cities in Australia for some time. CORS networks involve several GNSS base stations feeding information back to a central server, which then calculates and distributes high accuracy corrections to users, based on their location.

CORS networks are now being rolled-out to regional areas, allowing for agricultural users to connect to them. CORS networks are also spreading around the world, with many countries in Asia, Europe, and the USA now offering CORS correction signals to those beyond surveying.

This paper will discuss the concept, technical specifications, and payback of CORS Networks to agriculture. It will also profile some of the first CORS steered tractors in the world.

The principle of CORS networks

Why does agriculture need CORS networks?

Until recently, high accuracy GNSS positioning has only been of concern to surveyors. Since the rapid expansion of auto-steer technology, some believe that RTK use in Australian agriculture has overtaken surveying use. In recent years, other industries such as construction, mining, mapping, transport, and infrastructure have also identified the need for high accuracy positioning.

With the number of users growing rapidly there has been a massive over-capitalisation of basic GNSS infrastructure, primarily base stations (which provide the ability to deliver high accuracy positioning).

GNSS manufacturers have deliberately made their base stations incompatible with other systems via a range of techniques in both hardware and software. This has included using:

1. Proprietary communication formats;
2. Proprietary hopping sequences;
3. Different radio types (e.g. UHF/VHF designated channel, UHF spread spectrum); and,
4. Unlock codes.

This basically means that in most cases base stations cannot be shared between manufacturers.

The possible area covered by 4,000 base stations (assuming an 8km radius from each base station) would be enough to provide the whole cropping region of Australia twice using CORS networks. If one assumes that each base station has cost, on average, \$20,000, then agriculture has invested around \$80M in base stations; with only approximately 10-20% of farmers having invested in RTK so far. In comparison, the whole GPSnet project in Victoria (which will cover the whole of Victoria by 2011) will cost around \$6.5M (Victorian Department of Sustainability and Environment, 2009).

How CORS works

Unlike corrections coming from a single base station to the rover unit, networked RTK uses signals from several base stations and models the atmospheric and satellite errors. These base stations are installed to a high standard to ensure data integrity (Figure 1). They are typically “GNSS future proof” (i.e. can accept signals from current and proposed satellites) and have built-in mechanisms to prevent multipathing. Base stations are typically placed approximately 70km or less apart (Hale and Oates, 2009). Further testing and technological advancements may in fact increase the distance required to deliver high accuracy signal.



Figure 1. A CORS network base station in the GPSnet network (Hale and Oates, 2009).

Servers using software, such as SpiderNET from Leica Geosystems, then outputs correction information specific for the exact location of the rover unit. The signal is communicated using wireless technologies such as GPRS or NextG in rural areas. The user does not necessarily communicate directly with the base station in their area, but with the network signal from the centralised server (Figures 2 and 3).

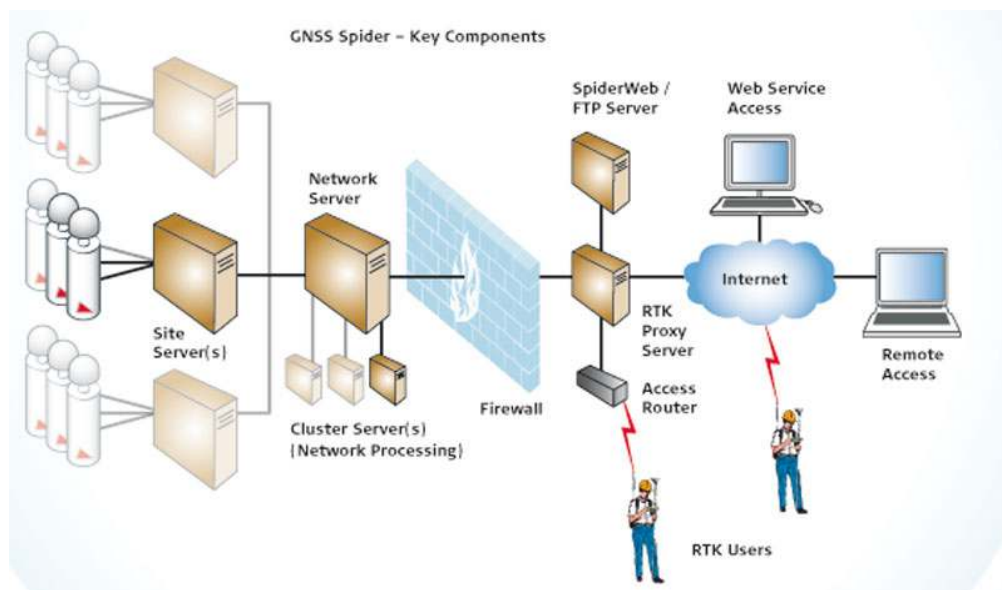

Figure 2. Diagram showing components of a CORS network (Leica Geosystems).



Figure 3. Diagram showing the theory of CORS networks in the field (Leica Geosystems).

Why CORS networks are better than having your own base station

CORS networks offer the following advantages:

1. CORS networks operate an open, non-proprietary format called RTCM. This allows multiple manufacturers to use the same signal. In fact, many of the networks operating in Australia and overseas use base stations from different manufacturers in their respective networks.
2. Increased coverage. By spacing base stations at approximately 70km apart, a large area can be covered. This is advantageous in agricultural situations where a farmer may have several properties spaced too far apart for conventional radio coverage. This will also assist contractors moving through districts.
3. Improved availability. Radios that normally communicate from a single base station to a rover unit have inherent limitations, especially in built, undulating, or heavily treed environments. CORS does not rely on direct communication of the rover unit with the base station. Mobile coverage is then the biggest limitation.
4. Reliability and redundancy. CORS signals rely on several base stations to provide signal to the user, which therefore offers redundancy. There are examples of base stations now operating in agriculture with 30+ users relying on the one base station. If there is a failure, then this will impact significantly on many users. Maintenance of base stations in CORS is carried out by the operator of the network.
5. Higher accuracy. Due to corrections coming from several base stations, there is limited or no signal degradation the further the user is from the base station in single base situations.
6. Less capital investment. Users no longer need to purchase their own base station, which reduced the capital expenditure. Instead users pay an access fee. A company called SmartNet Australia has been established recently, and usage fees are as low as \$0.60/hr for agriculture users (plus data access through the in-built NextG modem).
7. Geodetic control. CORS networks are compliant with Australian standards, and are actually being used for state and national geodetic coordinate control, as well as tectonic plate movement monitoring.

The extent of CORS networks in cropping areas of Australia

CORS networks are spreading quickly across North America, Europe and many Asian countries. In Australia, the Victorian Government has led the way with almost a half of Victoria covered to date. A total of around 100 stations will be operational by 2011. Estimated benefits by 2030 could be as high as \$1,300M from the use of precise positioning in Victorian agriculture (Allen Consulting, 2008).

The NSW government currently has 21 stations operational and another three are being built. These are expected to be operational by time of writing, or soon afterwards. A further 46 stations will be established over the next five years. The government will spend \$7.25 million on capital development plus additional funds to operate and maintain the network (A. White 2009, pers. comm.).

The Queensland Government's SunPOZ network currently has six stations positioned around the greater Brisbane region, with several more planned across southern Queensland as part of a combined CRC for Spatial Information project.

Western Australia has government run and private networks. Landgate's role in establishing a network of Continuously Operating Reference Stations (CORS) across regional Western Australia began in June 2007 (Landgate, 2009). Three sites are already streaming data to Canberra and by July 2009 six more sites are expected to be fully operational. A total of 26 stations will be built over the next two years.

In July this year Leica Geosystems announced a large scale commercial trial using the Leica mojoRTK auto-steer platform on a new CORS network in South Australia. Working in conjunction with SmartNet, which operates CORS networks throughout North America and Europe, Leica Geosystems has a network of six base stations and covers an area of more than 1,000,000 ha. It stretches from Adelaide in the south, to Crystal Brook in the north, Kadina in the west and Tanunda in the east.

How does the machine communicate with the CORS network?

In the case of the mojoRTK system from Leica Geosystems, the unit has its own inbuilt modem for remote service and support through what's called VirtualWrench™. Data coming from the CORS network is provided directly into the unit using the NextG modem – no additional hardware is required (Figure 4). The system accepts signal directly from the network and is compliant with the communication formats.



Figure 4. Photo of NextG antennae (black) and GNSS receiver (white) of mojoRTK on tractor roof.

With other systems, an interface device is needed to communicate with the network and accept the NTRIP signal. Companies such as www.govertime.com or www.touchm2.com have developed products to interface between the rover and CORS network.

The Department of Sustainability and Environment has also tested a system using satellite broadband to deliver the signal via a re-broadcast radio to the tractor (Denham et al., 2007). A diagram showing the components of this system is shown in Figure 5 below. Latencies were within acceptable levels, and accuracy was tested and found to be within +/-2cm horizontally in a dynamic application (with 95% confidence interval).

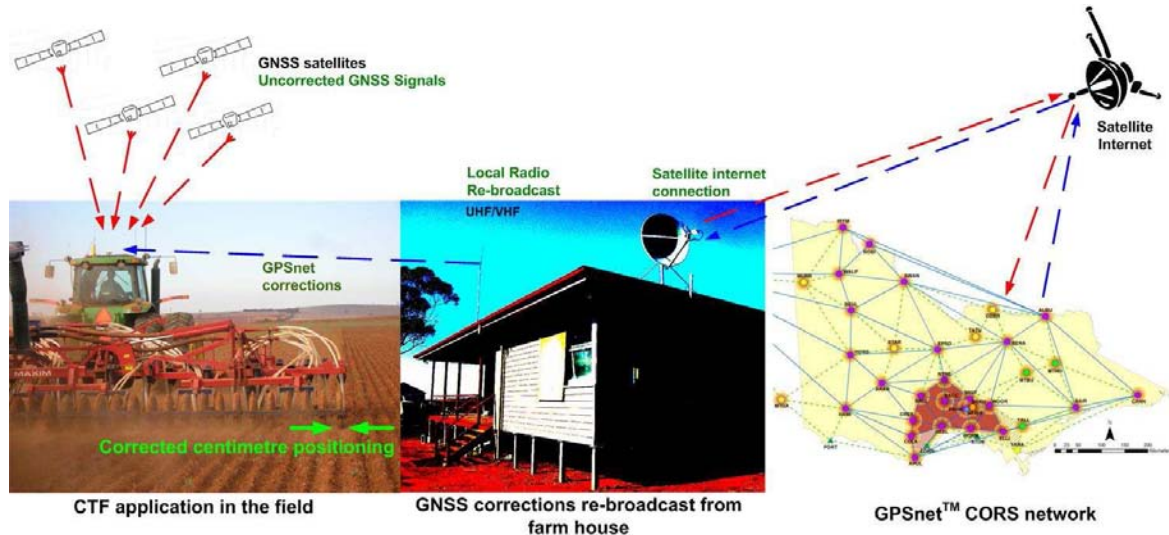

Figure 5. Diagram showing re-broadcast option for CORS networks (Denham, 2007).

References

- Allen Consulting 2008, 'Economic Benefits of High Resolution Positioning Services – Final Report', Allen Consulting Group.
- CTF Solutions 2008. Unpublished.
- Denham, J. et al. 2007, 'Networked Real-Time Kinematic corrections for high accuracy machine guidance - dynamic accuracy trials', Proceedings of the International Global Navigation Satellite Systems Society, IGNSS Symposium 2007, Sydney, Australia.
- Victorian Department of Sustainability and Environment 2009, 'GPSnet High Accuracy Satellite Positioning Network to Extend to Regional Victoria', fact sheet.
- Hale, M. & Oates, P. 2009, 'Vicmap position – information sheet', Victorian Government Department of Sustainability and Environment.
- Landgate 2009, Website of Western Australian Government, www.landgate.wa.gov.au.
- University of New South Wales 2007, 'Advanced RTK: Concepts and Operations', Course materials, School of Surveying and Spatial Information Systems.

Linking unmanned aerial vehicle (UAV) technology with precision agriculture

L. Felderhof^A, D. Gillieson^A, P. Zadro^B and A. van Boven^C

^A SkyView Solutions Pty Ltd

^B Saratoga Holdings Pty Ltd

^C Hinkler Park Plantations Pty Ltd

Corresponding Author: Leasie@skyviewsolutions.com.au

Farming presents a perfect opportunity to transfer the technology developed by Defence to day-to-day civilian use. A positive future is predicted for Unmanned Aerial Vehicles (UAVs), or drones, which are likely to follow a similar adoption path to the now ubiquitous satellite imagery and global positioning systems (GPS). The first step is to test possibilities and evaluate outcomes and limitations. To this end, Horticulture Australia Ltd facilitated a case study based on the macadamia industry. A ‘CropCam’ UAV (a radio controlled model plane, equipped with an autopilot, GPS and digital camera) was used to capture low-level, geo-referenced aerial photographs to assess the canopy health of macadamia trees. These portable planes provide images with a pixel resolution around 3 cm (at 400 ft altitude). They can operate below the clouds, providing ultra-high resolution images virtually on demand. Photo processing techniques allow the images to be linked directly with a GIS so they can be analysed in conjunction with other data layers.

The study showed that the UAV could reliably capture images according to a set flight plan, but further testing was required to fine-tune camera settings for efficient image processing. The UAV can simultaneously capture near infra-red data, so NDVI images can be created for assessing plant health. Differentiation of macadamia varieties and areas of tree-canopy yellowing could be seen. However, the air-frame was not indestructible - care has to be taken to find suitable landing areas and to match wind conditions with airframe capability. More detailed research is underway based on the initial findings.

The first step in ‘proving’ the technology is to establish relationships between what is seen from the air and what is present on the ground. Imagery obtained over an area with strong intra-paddock variation will be used for rigorous statistical analysis to compare patterns detected on the imagery with ground-based field data. Ground-truth data includes reflectance values measured with a hand-held radiometer and leaf analysis (N) of ‘healthy’ and ‘poor’ trees. From there, benefit-cost analysis will be undertaken to estimate potential savings in fertiliser application. Further exploratory analysis could elucidate other uses, such as early detection of tree decline and pest damage, improved water allocation, and targeted fertiliser applications. SkyView Solutions Pty Ltd is conducting the study in conjunction with Hinkler Park Plantations.

This project was funded by voluntary contributions from industry with matched funding from the Australian Government facilitated through HAL.

Measuring and mapping crop vigour using an active optical sensor in an ultra low-level aircraft

D.W. Lamb, M.G. Trotter and D.A. Schneider

Cooperative Research Centre for Spatial Information, Carlton, Victoria 3053 Australia and
Precision Agriculture Research Group, University of New England, Armidale, NSW 2351
Australia

Corresponding Author: dlamb@une.edu.au

Abstract

An ultra low-level aircraft carrying an active NIR/Red CropCircleTM sensor was successfully deployed at an altitude of 3-5 m over a 270 Ha field of skip-row sorghum (*Sorghum bicolor*) to record and subsequently map photosynthetically-active biomass (PAB) via the simple ratio (SR) index. The 2-D, ULLA-PAB map derived from 20 m transects was found to reproduce the gross patterns of spatial variability observed in a PAB map derived from a metre-resolution airborne digital multispectral image re-sampled to a similar spatial resolution. The fact that this type of sensor contains its own light source hence can be operated irrespective of ambient light conditions offers crop managers a viable alternative to conventional imaging technologies especially when they have day-to-day access to aircraft already conducting low-level operations, for example crop dusting and reconnaissance, over their agricultural fields.

Introduction

Airborne and spaceborne remote sensing technologies are often used in support of precision agriculture, and numerous reviews have been written illustrating the breadth of research and development activity and challenges faced by these technologies in servicing the needs of agricultural land management (for example Brisco et al. 1998; Bastiaanssen 2000; Lamb 2000; Moran 2000; Lamb and Brown 2001). Satellite imagery provides large scale coverage (tens to hundreds of square kilometres) and a number of current multispectral systems, for example IKONOS (Cook et al. 2001) and Quickbird (Wenzhong and Shaker 2004) provide metre (multispectral channels), if not sub-metre (for example Quickbird panchromatic channel) spatial resolution. Hyperspectral satellite imaging systems, for example the Hyperion imaging spectrometer onboard the EO1 satellite (Ungar et al. 2003) provides greater spectral resolution, but generally poorer spatial resolution. Large spatial coverage keeps the per hectare costs of imagery low, an attractive proposition for end-users although commercial viability from a provider's perspective requires large numbers of end-users be sourced within the image footprint.

Airborne imaging systems, both multi and hyperspectral have appeared over agricultural fields, by and large to fill perceived operational gaps in the performance of satellite image systems; providing greater spatial resolution for a given set of spectral performance criteria, user-defined spectral and spatial resolution, the ability to operate only over targets of interest (occupied by paying customers), increased operational flexibility in terms of capitalizing on weather and imaging conditions, for example their ability to operate under high cloud base (Lamb 2000) as well as being able to coincide with on-ground support activities (for example in support of image calibration).

Of all the parameters sensed by multispectral or hyperspectral imaging systems in agriculture, simple canopy indices that utilize the reflectance of plant canopies in the near infrared (NIR; ~770-1500 nm) and red (Red; ~630-680 nm) wavelength ranges (bands) dominate. These include, for example the normalised difference vegetation index, (Rouse et al. 1973), simple ratio, (Jordan 1969) and soil adjusted vegetation index, (Huete 1988). Useful discussions of the relationship between individual bands and derived indices and vegetation fraction and leaf pigments can be found in Gitelson et al. (2002; 2003) and recent reviews of multispectral indices for crop disease and vigour detection can be found in Huang et al. (2007) and Devadas et al.

(2008). Not only do the simple indices described above exhibit utility in mapping spatial variability in biophysical descriptors such as plant leaf area index (LAI), photosynthetically active biomass (PAB) and chlorophyll content, with potential ability to correlate to crop yield and/or quality, but the broad-band, multi-spectral imaging systems necessary to collect data in these wavebands are relatively simple.

After almost 25 years of sensor research and development, and the proliferation of commercial image providers offering services to agricultural land managers, timely service delivery remains challenged by the need to match the availability of aircraft, pilot, and system operator, when weather and in-field conditions (including crop phenology, pest incursion, disease outbreak) and/or the availability of on-ground agronomic support staff are aligned. In Australia, the interval between request and acquisition or delivery of image products can range from one week to one month although this may be offset by advanced booking, in particular when it comes to scheduling for, say, crop anthesis. However use of derived map products for application of insecticides, foliar nutrients or growth regulators requires a considerable degree of scheduling flexibility which still challenges some image providers. Even when these factors fall into place it is not uncommon for scheduled imagery to be limited by climatic events such as low cloud.

Image calibration standards vary from provider to provider; some imagery is delivered calibrated to at-sensor radiance while others use raw digital numbers. Very few providers deliver imagery calibrated to on-ground reflectance values, unless the scope of the project (and hence cost) includes the additional on-ground work required to establish calibrated reflectance targets within the image field of view. The use of at-sensor radiance or sensor-generated digital numbers distort the values of derived band ratios compared to those measured using on-ground reflectance values because the spectral information 'arriving' at an overhead sensor will be influenced by the atmospheric path traveled by the incident radiation (Chavez 1996; Edirisinghe et al. 2001) or the sensor gain and offset values which governs the production of electrical signals from the sensor in response to incident photons. Between target and sensor, the radiation is influenced by a number of wavelength-dependent factors including scattering, absorption and refraction. Scattering of additional radiation into the field of view of the sensor is generally considered an additive effect whilst transmission effects (absorption and scattering out of the field of view) is considered a multiplicative effect (for example refer to references cited within Chavez, 1996). A considerable amount of work has been conducted to investigate the effect of path radiance effects on airborne remotely sensed imagery and to correct such imagery in order to reproduce at-ground reflectance values for targets (for example Edirisinghe et al. 2001).

The development of portable, hyperspectral, field radiometers that rely on reflection of ambient light from crop canopies was initially motivated by the requirement to calibrate overhead at-sensor radiance measurements to on-ground, plant canopy reflectance. However passive, hyperspectral radiometers have also been used in their own right to measure biophysical descriptors in crops (for example Huang et al. 2007 and references within).

More recently, active multispectral sensors have been developed for on-ground use (Künemeyer et al. 2001; Middleton et al. 2004; Holland et al. 2004; Inman et al. 2005). The key advantages of these sensors is that they contain their own light source and if used in conjunction with synchronous detection, can be operated irrespective of the ambient light conditions (including at night). Also, if the ratio of two wavebands are used, and the optical, sensor-target characteristics of each source are the same, then derived band ratios are absolute, not distorted by path radiance effects and insensitive to metre-scale variations in sensor-target distances so long as they are operated within the linear, optical response range of the internal sensors. Utilizing both Red and NIR wavebands to create NDVI or similar indices, these sensors are finding a range of in-crop manual or vehicle applications including on-the-go nitrogen top-dressing (Inman et al. 2005; Solari et al. 2008), weed spraying (Sui et al. 2008) and biomass estimation (Künemeyer et al. 2001; Flynn et al. 2008; Trotter et al. 2008).

There is a distinct opportunity to combine the desirable attributes of on-ground, active R/NIR sensors, including their relatively low cost, compact size and low weight, with the ability of low-flying aircraft to cover large tracts of ground very quickly, especially those aircraft normally over-flying the crops of interest during field scouting and crop-dusting. Consequently, this paper

describes the assembly, deployment and preliminary evaluation of an active, on-ground, R/NIR plant canopy sensor in an ultra-low level aircraft for recording and mapping crop vigour via the simple ratio (SR) index.

Materials and Methods

The Sensor

The sensor selected for the trial was the CropCircleTM ACS210 (Holland Scientific, Lincoln NE USA), 'red head', coupled to a Geoscout 400 datalogger (Holland Scientific, Lincoln NE USA). This sensor emits radiation from light emitting diodes (LEDS) with peak emission wavelengths at 650 nm and 880 nm (Holland et al. 2004). The LED-lens configuration provided an approximately collimated beam with a source-ground footprint divergence angle of approximately 32° x 6°, or when orientated with the long-axis at right angles to the direction of travel, a footprint of approximately (0.57 x sensor altitude AGL) and (0.11 x sensor altitude AGL) across and along the direction of travel, respectively (Holland Scientific 2004).

A simple laboratory test involving measuring the CropCircleTM output with increasing distance from a homogenous target (> 1 m) confirmed that the individual Red and NIR signal output from the detectors followed an inverse power law with increasing source-target distance whereas resulting NDVI and SR values appeared invariant for distances up to 6.5 m (Lamb et al. 2009). These results set an effective upper-limit of ~ 6 m to the operating altitude of the sensor above the crop canopy.



Figure 1. Photograph of the Fletcher FU24954 (VH-EQC) crop-dusting aircraft and the CropCircle mount (inset). The sensor was positioned in a nadir-view configuration with the long-axis of the LED array at right angles to the flight direction.

The CropCircle sensor was mounted in a nadir-viewing configuration underneath a Fletcher FU24954 (VH-EQC) crop-dusting aircraft (Figure 1) with the long axis of the source LEDs orientated at right angles to the forward direction of the aircraft. The datalogger was attached inside

the cockpit to allow the pilot to trigger the recorder at the commencement and completion of the acquisition process.

Positional information was provided from a 5 Hz global positioning system (Garmin GPS18 x 5 Hz, Olathe, Kansas USA); a low-cost GPS sensor for use agricultural applications. The GPS-datalogger configuration used allowed for a dynamic interpolation of the 5Hz location/velocity records to provide an effective 20 Hz position calculation rate in the datalogger. Whilst the sensor head provides an optical output signal at 200 Hz, Red and NIR reflectance values were recorded at approximately 20 Hz to coincide with positional records interpolated from the GPS data string.

The fieldsite and data acquisition

The active optical sensor evaluation was conducted over a 270 ha field of grain Sorghum (*Sorghum bicolor*) located at Collymongle Station, northwest New South Wales, Australia (Lat 29° 25' S, Long 148° 53' E). The sorghum was planted in a skip-row configuration (2 m- 2 row raised bed, 2 m skip-row) with rows orientated WNW-ESE and at the time of sensor evaluation the crop was between stages 5 (boot stage) and 6 (half bloom) (Vanderlip and Reeves 1972).

Crop biomass measurements were conducted at 17 locations within the field, the location of each was recorded using a differential global positioning system (DGPS, Trimble, Sunnyvale California). On-ground measurements of SR was acquired using a second hand-held CropCircle unit by walking 8, parallel, across-row transects within a 10m x 10 m region centred on the recorded dGPS position. The on-ground Cropcircle sensor records were collected at a minimum rate of 1 Hz, and the walking pace maintained constant at approximately below 1 ms⁻¹ to ensure a consistent proportion of crop row and skip-row coverage. The SR value was calculated from each of the Red and NIR sensor records and averaged over the 10 m x 10 m region. Crop samples were subsequently collected by cutting to ground level, 3 x 1m-long row segments selected at random within the 10 m x 10 m region. The samples were oven dried at 40°C, weighed, and weights converted to kg of dry matter per ha (kg DM/ha).

The ultra low-level airborne (ULLA) sensor was flown on 17th December 2008 between 9.30 am and 10.30 am local time (Australian Eastern Daylight Savings Time- AEDT). Sensor data was collected at an altitude of 3-5 m above ground level (AGL) in NNE-SSW transects (at right angles to the crop rows), spaced 20 m apart and at a speed of 40 m s⁻¹ (approximately 80 knots indicated airspeed). At a mid-range sensing altitude of 4 m AGL, the CropCircle footprint on the crop canopy measured approximately 2.3m across x 0.5 m along the direction of travel. Instantaneous sensor Red and NIR reflectance values were used to calculate the SR. The ULLA sensor point data was block kriged using a 25 m block size and an exponential semi-variogram model using the computer program Vesper (Whelan et al. 2001) and then re-sampled to a 10 m grid.

For the purposes of comparison, a digital image of the same field was acquired on the same day, using SpecTerra Service's digital multispectral airborne imaging system, a four band, frame transfer-type imaging sensor. Whilst the sensor contained 4 available image channels, only the 677 nm (Red, bandwidth 18 nm) and 781 nm (NIR, bandwidth 20 nm) wavebands were subsequently analysed. Imagery was acquired at an altitude of 1800 m AGL to provide a spatial resolution (pixel size) of approximately 1 m. The images were acquired at 8:48 am local time, equating to a solar zenith angle of 56°, and azimuth angle of 98°. Individual frames of image data were corrected using SpecTerra Service's proprietary sensor geometric and radiometric techniques. Given the ±14° field of view of the imaging system, the slope of the bidirectional reflectance distribution function (BRDF) surface for the Red and NIR bands were observed to be very similar, meaning that calculation of the SR image from the ratio of the Red and NIR image bands was deemed sufficient to remove the BRDF from the SR image (Dr Frank Honey, SpecTerra Services, Personal Communication 2009). The SR image was finally re-sampled image to a 10 m grid.

Results and Discussion

An investigation of the logged ULLA sensor data showed the datalogger recorded the GPS/CropCircle data at approximately 17 Hz rather than the expected 20 Hz. A plot of the SR values returned from the ULLA sensor for a 633 m segment of a transect is depicted in Figure 2. This length of segment includes 158 skip-rows with a data sampling interval of 2.4 m along the direction of travel. The physical spacing of sampled data points (2.4 m) compared to the crop and skip-row interval (2 m) immediately suggests the existence of a Moiré effect resulting from the beating of the sensor sampling and skip-row frequencies (Kafri and Glatt 1990). For an aircraft forward speed of 40 m s⁻¹ this equates to a beat frequency of ≈ 3 Hz, or every 6 data points. The sensor footprint of 0.5 m in the forward direction of motion, coupled with the deflection of the footprint resulting from small attitude changes in the aircraft may reduce the contrast between the crop and skip-row response. The frequency distribution of the SR values for each sensor (Figure 3) are consistent with this; the airborne sensor-derived SR values exhibit a normal distribution (Figure 3a) while the ULLA sensor values are slightly skewed towards the higher SR values (Figure 3b). The 2.4 m sampling resolution of ULLA sensor will always result in a lower number of bare soil records in the available clear skip-rows compared to the 1 m resolution of the imagery.

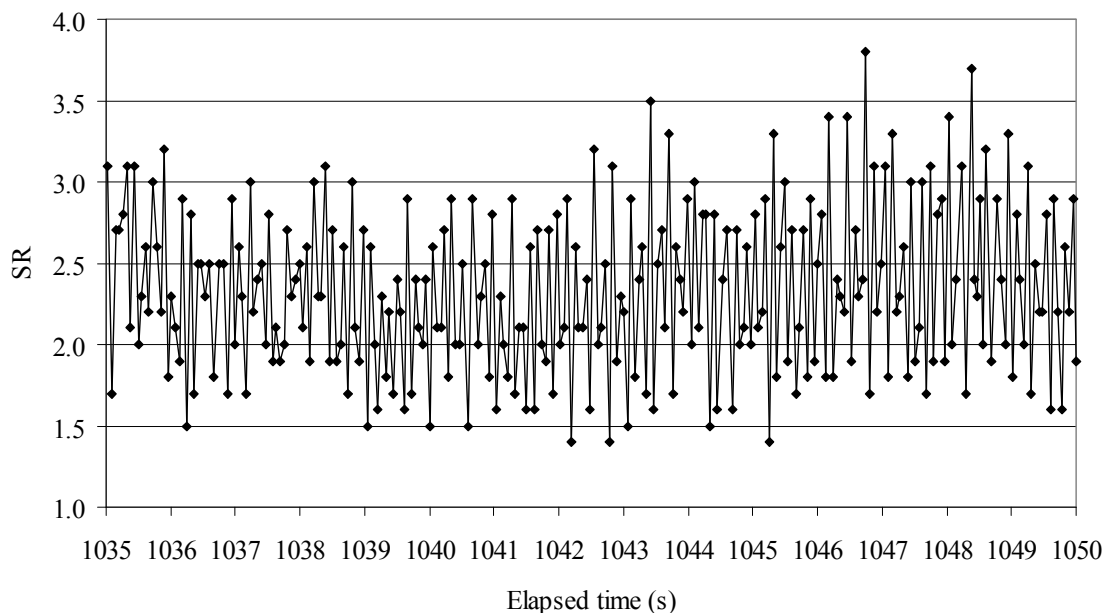

Figure 2. Sequence of SR values recorded from a 633 m long segment of a transect.

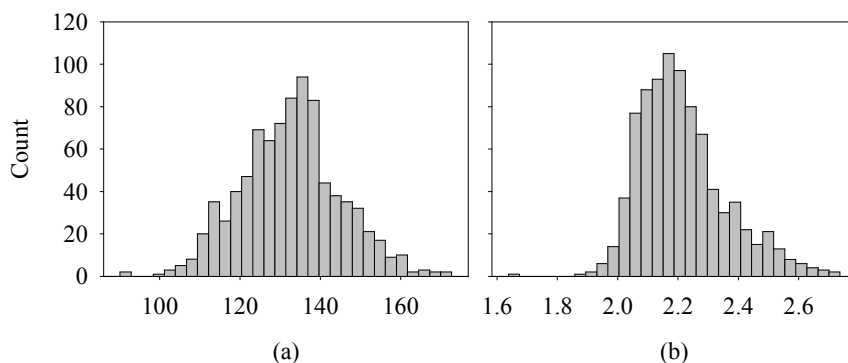

Figure 3. Frequency distribution histograms for the (a) multispectral image-derived SR values (re-sampled to 10 m grid) and the (b) ULLA-SR values (block kriged using 25 m block then re-sampled to 10 m grid).

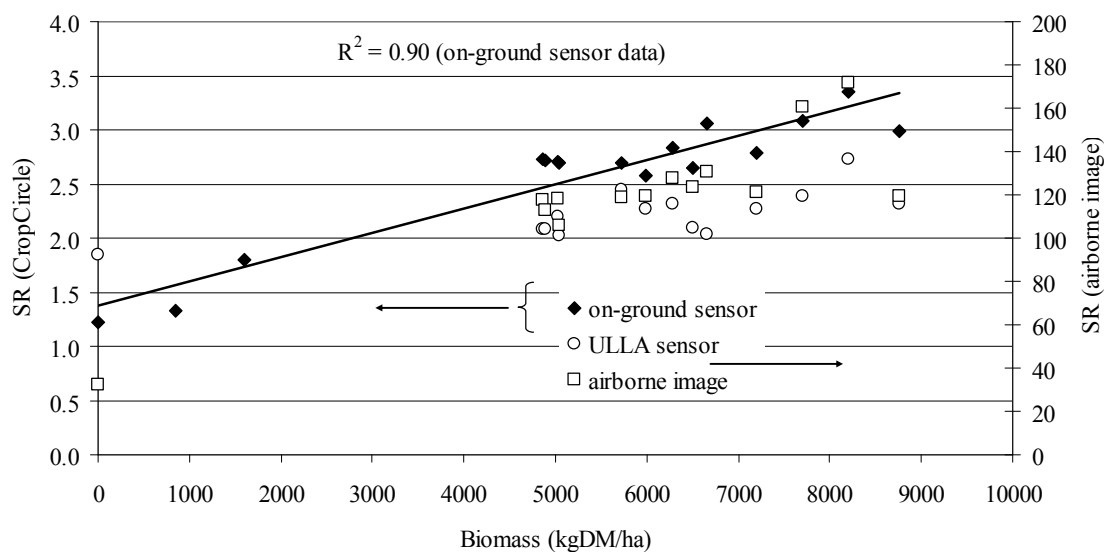

Figure 4. Scatterplot of SR versus biomass (kg DM/ha) for each of the on-ground and ULLA CropCircle sensors (kriged data re-sampled to 10 m grid), and for the 1 m resolution multispectral airborne image re-sampled to 10 m grid.

A scatterplot of SR values as a function of biomass (kg DM/ha) is given for each of the on-ground and ULLA CropCircle sensors, and for the 1 m resolution airborne multispectral image (Figure 4). Here the block kriged, ULLA sensor, point data was re-sampled to a 10 m grid and the SR value coincident with dGPS plot location was extracted. The airborne digital SR values were similarly extracted from dGPS location by re-sampling image to a 10 m grid and extracting the coincident point SR value.

The most obvious feature of Figure 3 is the fact that the SR values for the on-ground and ULLA sensors are completely different to those extracted from the airborne multispectral image. The ULLA and on-ground sensor data are absolute ratios based on the active light sources contained within the CropCircle units and these have been observed to be invariant with sensor target distances from 1 to 6 m (Lamb et al. 2009). The airborne image-derived SR values are derived from the conversion of at-sensor radiance to DN- here a function of the gain and offsets of each of the cameras used in the sensor. Effectively the airborne image-derived SR values, in the absence of any DN/on-ground reflectance calibration are arbitrarily scaled. Notwithstanding the scaling issues, all sensors appear to record a linear increase in SR values with increasing biomass, for example $R^2 = 0.90$ for the on-ground sensor (Figure 4). Much of the scatter in these plots, especially those from the ULLA sensor and airborne imagery, is attributed to the method by which point or pixel data were processed to a 10 m grid. The ULLA sensor SR values appear less sensitive to increases in biomass (Figure 4). This is most likely due to the fact that the ULLA point data was kriged to a 25 m grid prior to re-sampling, resulting in an elevated the SR for the bare soil calibration location (0 kg DM/ha).

A PAB map created from the ULLA sensor log is given in Figure 5, along with the PAB map created from the 1 m resolution digital multispectral airborne image. Here the block-kriged ULLA data is re-sampled to a 10 m grid and the airborne image-derived SR map, the image also re-sampled to the same 10 m grid.

The gross spatial variability features in the ULLA-PAB map appears similar to that of the airborne image-derived PAB map, although the higher spatial resolution of the original airborne image (1 m) compared to the 25 m block kriging used for the ULLA point records is evident in the 'graininess' of the image-derived map. There is a region in the lower right quadrant of the ULLA-PAB map that appears to have noticeably higher SR values than the corresponding image-derived PAB map. Following the earlier discussion regarding the spatial sampling resolution of the two sensors, the Moiré effect in ULLA sensor records may have produced elevated SR values

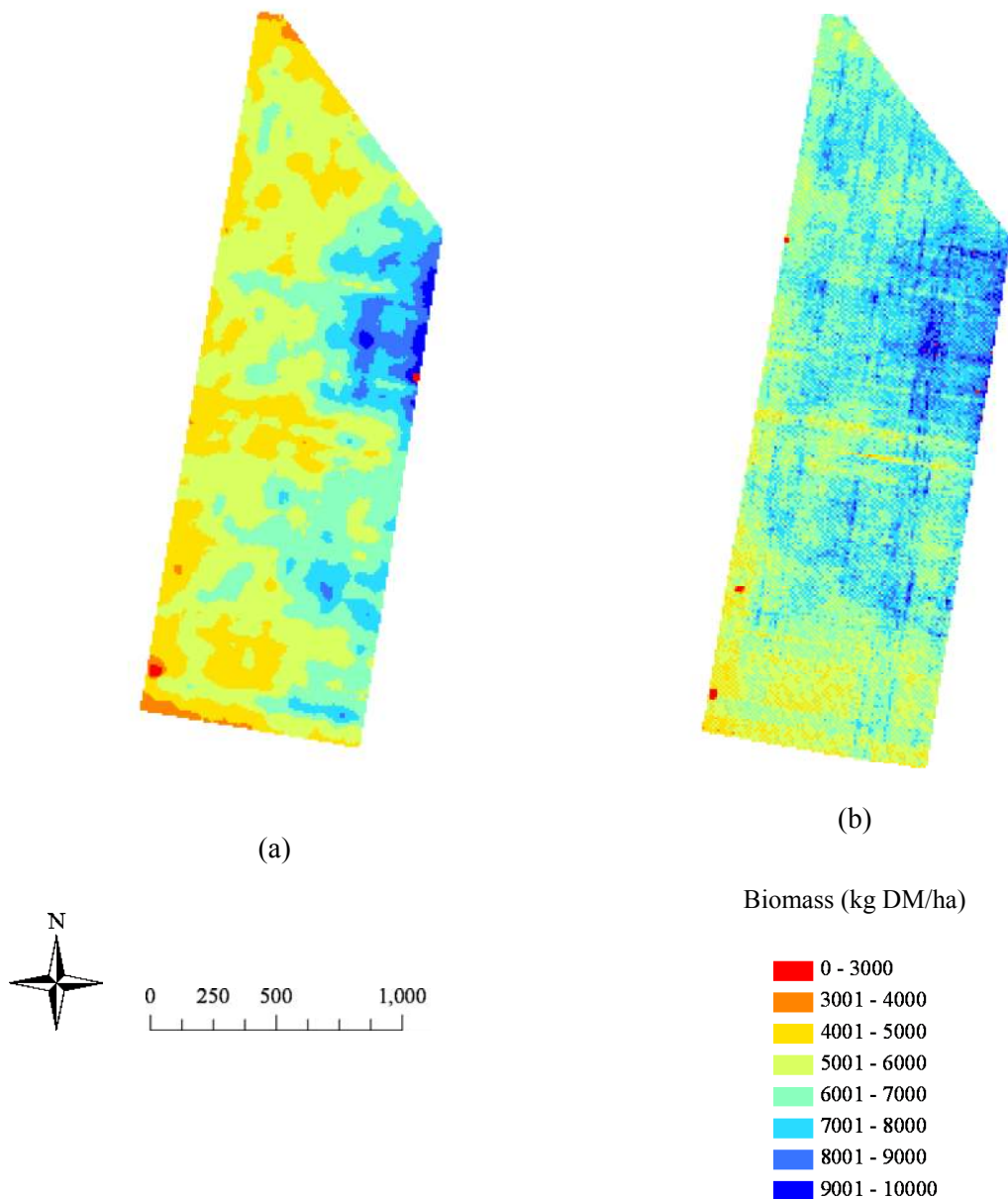

Figure 5. Biomass maps rendered by (a) block kriging the ULLA point SR data using a 25 m block size and an exponential semi-variogram model, and then re-sampling to a 10 m grid, and (b) re-sampling an airborne digital SR image to a 10 m grid.

compared to the imagery. However it should also be recognized that the multispectral image of the field was created from a mosaic of four image frames and one of the mosaic seams exists in this region; this small discrepancy may have arisen during the process of mosaicing the reference imagery together. The acquisition of the multispectral imagery used in this work was timed to ensure the solar zenith angle exceeded the field of view of the sensor, thereby reducing BRDF effects, and ultimately avoiding the need to apply a correction process over and above simply calculating the SR. However, other commercial image providers may not have such flexibility or experience, and taken with all the scheduling considerations discussed earlier, it is possible that acquired imagery may suffer from, and require additional correction for, BRDF effects which will likely be crop- as well as phenology-specific. The active optical sensor approach, involving a nadir-viewing sensor moving over the top of the crop, is not influenced by such BRDF effects, nor any

potential distortion of values resulting from the mosaicing of high-spatial resolution image frames together.

At 40 ms⁻¹, and flying 20 m transects, the ULLA sensor surveyed the entire 270 ha field in approximately 1 hour. An airborne imaging system with a 2 km x 2 km image footprint could cover up to 300 - 350 square kilometres of survey in this same period if there is sufficient area to fly, and depending on the contiguity of the target areas (Dr Frank Honey, SpecTerra Services, Personal Communication 2009). Thus, practical applications of the ULLA, active sensors remain limited by the speed at which they can be flown. The real advantages of the ULLA active sensors is that they are relatively inexpensive (~US\$5,000), lightweight (<400 g) and generally small in size (~500 cm³), making it possible to retro-fit them to the outer shell of agricultural aircraft and allowing 'piggy-back' deployment during other low-level agricultural operations, for example crop-dusting.

Conclusions

An ultra low-level aircraft (ULLA) carrying an active NIR/Red CropCircle™ sensor was successfully deployed at an altitude of 3-5 m over a 270 ha field of skip-row sorghum to record and subsequently map photosynthetically active biomass (PAB) via the simple ratio (SR) index. A comparison of the 2-D ULLA-PAB map derived from 20 m transects was found to reproduce the gross features of a PAB map derived from a metre-resolution airborne digital multispectral image re-sampled to a similar spatial resolution. Using a relatively low-cost GPS, it was possible to log SR/GPS records at a frequency of 17 Hz. The Moiré effect resulting from the difference between the sampling frequency of the ULLA sensor and the 2 m skip-row interval reduced the proportion of bare-soil skip-rows sensed compared to that appearing in the multispectral image, slightly modifying the distribution of the SR values derived from each sensor. Nonetheless, the ULLA-PAB map did reproduce the gross spatial variability observed in the PAB map derived from the airborne multispectral image of the field.

These sensors are active hence can be operated irrespective of ambient light conditions and at night, are of relatively low cost, lightweight, small in size and can easily be retro-fitted to the outer shell of aircraft, requiring only a hole large enough to allow a cable to pass through into the cockpit. Consequently active ULLA sensors provide farm managers an alternative to conventional imaging technologies especially when involving aircraft already conducting low-level operations, for example crop dusting and reconnaissance, over agricultural fields.

Acknowledgments

This work was conducted within the CRC for Spatial Information (CRCSI), established and supported under the Australian Governments Cooperative Research Centres Programme. The authors acknowledge the support of David Boundy (Superair) for provision of the aircraft and conducting the necessary modifications for the trial, Nick Barton (Twynam Agriculture) for providing access to the fieldsite, and Andrew Smart (Precision Cropping Technologies), Andrew Parkes (Sundown Pastoral Company) and Dr. Frank Honey (SpecTerra Services) for helpful discussions concerning the interpretation of the airborne multispectral imagery. Specific mention of the names of commercial data providers (eg SpecTerra Services) or product brand names (eg CropCircle™) does not constitute an endorsement of that particular provider or product.

References

- Bastiaanssen, W.G. M., Molden, D. J., Makin I. W. (2000). Remote sensing for irrigated agriculture: examples from research and possible applications. *Agricultural Water Management*, 46 (2), Pages 137-155.
- Brisco, B., Brown, R.J., Hirose, T., McNairn, H., Staenz, K. (1998). Precision agriculture and the role of remote sensing: a review. *Canadian Journal of Remote Sensing*, 24 (33), 315-327.
- Chavez, P.S. (1996). Image-based atmospheric corrections- revisited and improved. *Photogrammetric Engineering and Remote Sensing*, 62 (9), 1025-1036
- Cook, M.K., Peterson, B.A., Dial, G., Gibson, L., Gerlach, F.W., Hutchins, K.S., Kudola, R., Bowen, H.S. (2001). IKONOS technical performance assessment. In S.S. Shen, M.R. Descour

(Eds.), Proceedings SPIE, Algorithms for Multispectral, Hyperspectral, and Ultraspectral Imagery VII, 4381, 94-108.

Devadas, R., Lamb, D.W., Simpfendorfer, S., Backhouse, D. (2008). Evaluating ten spectral vegetation indices for identifying rust infection in individual wheat leaves. Precision Agriculture, DOI 10.1007/s11119-008-9100-2.

Edirisinghe, A., Chapman, G.E., Louis, J.P. (2001). A simplified method for retrieval of ground level reflectance of targets from airborne video imagery. International Journal of Remote Sensing, 22 (6), 1127-1141.

Flynn, E.S., Dougherty, C.T., Wendroth, O. (2008). Assessment of pasture biomass with the normalized difference vegetation index from active ground-based sensors. Agronomy Journal, 100, 114-121

Gitelson, A.A., Kaufman, Y.J., Stark, R., Rundquist, D. (2002). Novel algorithms for remote estimation of vegetation fraction. Remote Sensing of Environment, 80 (1), 76-87.

Gitelson, A.A., Gritz, Y. Merzlyak, M.N. (2003). Relationships between leaf chlorophyll content and spectral reflectance and algorithms for non-destructive chlorophyll assessment in higher plant leaves. Journal of Plant Physiology, 160, 271-282.

Holland Scientific. (2004). Crop Circle ACS-210 User's Guide. Holland Scientific, Inc
5011 South 73rd Street Lincoln, NE 68516-4236 USA, 7 pages.

Holland, K.H., Schepers, J.S., Shanahan, J.F., Horst, G.L. (2004). Plant canopy sensor with modulated polychromatic light source. In D.J. Mulla (Ed.), Proceedings of the 7th International Conference on Precision Agriculture and Other Precision Resources Management, Precision Agriculture Center, University of Minnesota, Department of Soil, Water and Climate.

Huang, W., Lamb, D.W., Niu, Z., Zang, Y., Liu, L., Wang, J. (2007). Identification of yellow rust in wheat using in-situ spectral reflectance measurements and airborne hyperspectral imaging. Precision Agriculture, 8, 187-97.

Huete, A.R. (1988). A soil-adjusted vegetation index (SAVI). Remote Sensing of Environment, 25, 295-309.

Inman, D., Khosla, R., Mayfield, T. (2005). On-the-go active remote sensing for efficient crop nitrogen management. Sensor Review, 25 (3), 209-214.

Jordan, C.F. (1969). Derivation of leaf-area index from quality of light on the forest floor. Ecology, 50, 633-666.

Kafri, O., Glatt, I. (1990). The Physics of Moiré Metrology. New York: John Wiley and Sons.

Künnemeyer, R., Schaare, P.N., Hanna, M.M. (2001). A simple reflectometer for on-farm pasture assessment. Computers and Electronics in Agriculture, 31 (2), 125-136.

Lamb, D. W. (2000). The use of qualitative airborne multispectral imaging for managing agricultural crops– A case study in south eastern Australia. Australian Journal of Experimental Agriculture, 40 (5), 725-738.

Lamb, D.W., Brown, R.B. (2001). Remote sensing and mapping of weeds in crops- A review of airborne remote sensing. Journal of Agricultural Engineering Research, 78 (2), 117-125.

Lamb, D.W., Trotter, M.G., Schneider, D.A. (2009). Ultra low-level airborne (ULLA) sensing of crop canopy reflectance: A case study using a CropCircle™ sensor. Computers and Electronics in Agriculture, 69 (1), 86-91.

Middleton, E.M., McMurtrey, J.E., Corp, L.A., Campbell, P.K.E., Butcher, L.M., Chappelle, E.W. (2004). Nitrogen stress in corn as detected and monitored by fluorescence and optical reflectance measurements. In S. Stamatiadis, J.M. Lynch and J.S. Schepers (Eds.), Remote sensing for agriculture and the environment (pp. 150-173). Peripheral Editions: Larissa Greece.

- Moran, M.S. (2000). New imaging sensor technologies suitable for agriculture management. In R.J. Bryson, W. Howard, A.E. Riding, L.P. Simmonds, M.D. Steven (Eds.), *Remote Sensing in Agriculture, Aspects of Applied Biology*, 60, 1-10.
- Rouse, J.W. Jr., Haas, R.H., Schell, J.A., Deering, D.W. (1973). Monitoring vegetation systems in the great plains with ERTS. *Proceedings of the 3rd ERTS symposium. NASA SP-351 1* (pp. 309–317). US Government Printing Office: Washington DC.
- Solari, F., Shanahan, J., Ferguson, R., Schepers, J., Gitelson, A. (2008). Active sensor reflectance measurements of corn nitrogen status and yield potential. *Agronomy Journal*, 100, 571-579.
- Sui, R., Thomasson, J.A., Hanks, J., Wooten, J. (2008). Ground-based sensing system for weed mapping in cotton. *Computers and Electronics in Agriculture*, 60 (1) 31-38.
- Trotter, T.F., Frazier, P.F., Trotter, M.T., Lamb, D.W. (2008). Objective biomass assessment using an active plant sensor (Crop Circle), preliminary experiences on a variety of agricultural landscapes. *Proceedings of the 9th International Conference on Precision Agriculture*, Denver Colorado.
- Ungar, S.G., Pearlman, J.S., Mendenhall, J.A., Reuter, D. (2003). Overview of the Earth Observing One (EO-1) mission. *IEEE Transactions on Geoscience and Remote Sensing*, 41 (6), 1149-1159.
- Vanderlip, R.L., Reeves, H.E. (1972). Growth Stages of Sorghum [*Sorghum bicolor*, (L.) Moench.]. *Agronomy Journal*, 64, 13-16.
- Wenzhong, S., Shaker, A. (2004). Approximate approaches to geometric corrections of high resolution satellite imagery. *Journal of Geo-Spatial Information Science*, 7 (1), 24-30.
- Whelan, B.M., McBratney, A.B., Minasny, B. (2001). VESPER- spatial prediction software for precision agriculture. In G. Grenier and S. Blackmore (Eds.), *ECPA2001. Proceedings of the 3rd European Conference on Precision Agriculture* (pp 139-144). Montpellier France: Agro-Montpellier.

Precise nutrient management in China supported by remote sensing and information technology

K. Wang

Institute of Agricultural Remote Sensing and Information Technology,
Zhejiang University, PR China

Corresponding Author: kwang@zju.edu.cn

Excess application of fertilizer in fields is quite common in China, primarily because the fertilizers are applied according to the experiences and customs of farmers. Field fertilizer recommendation maps, produced by GIS and geostatistics based on soil surveying and testing, are being developed to advise local government and farmers on fertilization application rates and strategies. The fertilizer maps are able to be searched through the Local Agricultural Information System or Google Earth.

The opportunities, challenges, advantages and methodology of integrating local SPAD measurement, scanned leaf profiles, digital imagery and canopy spectra to assess crop nutrients levels have been studied through both plot and field experiments. Quick and easy field nutrient diagnosis methods have been established and applied to commercial production systems.

Field trials involving digital imagery taken from unmanned aerial vehicles (UAV) and the use of 3G mobile phones to capture ancillary data have been conducted to evaluate crop nutrients levels. The preliminary results are promising and a fertilizer application, expert system operated by PDA and mobile phone has been developed for industry adoption.

On-farm carbon and biodiversity: mechanisms and Precision Agriculture tools for the future

P. Frazier^A, T. Trotter^A and E. Garraway^B

^A Eco Logical Australia, Armidale, NSW 2350, Australia

^B Cooperative Research Centre for Spatial Information, Carlton, Victoria 3053 Australia and Precision Agriculture Research Group, University of New England, Armidale, NSW 2351 Australia

Corresponding Author: paulf@ecoaus.com.au

Modern farms are no longer just agricultural production units. The environment, including biodiversity offsets, carbon sequestration and ecosystem services, offer new and potentially important markets for farming enterprises. However, understanding these new opportunities, accounting for what resources your farm may contain and providing a legally acceptable ongoing measure of the state of these resources is difficult. Some of these markets are yet to be defined by government, while others which are currently available are relatively complex. It is clear that the importance of these potential markets will continue to grow and clear market mechanisms for at least aspects of these markets will be developed in the near future. The aims of this paper are to describe the main environmental markets currently in existence or likely to be available in the next few years; and to describe current PA tools and techniques for measuring and monitoring these commodities.

Current environmental markets include bio-diversity offsets (including biobanking), while soil carbon is the current popular ‘buzz’ market and other ecosystem services are starting to gain interest. Biodiversity offsets are a system where those conducting large development projects that take in areas of recognised important environments can ‘offset’ their impact by securing a parcel of land with similar values and making arrangements for future management and improvement of these areas. Soil carbon markets are being considered carefully by many sectors, it is likely that a market for increasing and securing soil carbon will exist soon.

Some of these markets exist and some are being developed. Quantifying quality of the ‘resource’ and providing market acceptable information on the ongoing state of the resources are areas where PA tools and techniques may provide cost-effective information. High quality native vegetation habitats are generally heterogeneous, diverse and difficult to map and monitor. New high resolutions satellite imagery and airborne laser systems (ALS or LIDAR) offer the potential to describe the diversity and extent of these systems across large areas and provide on-going monitoring information. Soil carbon can vary dramatically across a paddock or property and down the soil profile. Rapid techniques to quantify soil carbon at property scales need to be developed before this market can work. EM survey techniques may provide non-invasive methods to describe key soil characteristics across large areas, while on-the-go in-ground NIR sensors are showing potential to provide rapid soil carbon measures.

Autonomous tracking and control of livestock in extensive grazing systems

D.L. Swain

CSIRO Livestock Industries, JM Rendel Labs, Ibis Avenue, Rockhampton, QLD 4701, Australia

Corresponding Author: dave.swain@csiro.au

Recent advances in wireless sensor networks coupled with global positioning systems (GPS) are providing new opportunities to monitor and manage livestock in extensive grazing systems. Belmont Research Station, based near Rockhampton in Central Queensland, has been the test bed for a series of research projects that have integrated static and mobile sensors and actuators. Recent projects have explored social behavioural interactions of herds of cattle including cows, calves and bulls. The results from monitoring social behavioural interactions have identified a number of potential behavioural phenotyping methods. In particular the opportunity to automatically characterise maternal variance and derive information on fertility indicators has the potential to establish improved phenotypes. Further work using high sample rate (up to 4Hz) GPS has been exploring livestock landscape preference indices and movement patterns within and between groups of cattle. These data are being coupled with behavioural classification techniques to determine the motives behind landscape use by cattle. As we improve our understanding of behavioural processes we are integrating the information within an automated cattle control system (virtual fencing). Whilst there are significant challenges in attempting to deliver a fully automated animal control system, recent research has been working toward a virtual fencing proof of concept. The most recent work has focussed on controlling cattle in environmentally sensitive areas and has succeeding in controlling groups of up to forty cattle over several weeks. There is still some way to go before this technology will be ready for commercial use, however, through focussed refinement we are hopeful to demonstrate the potential to meet environmental protection goals. The talk will provide information on the technologies that have been established to deliver autonomous tracking and control of livestock in extensive grazing systems. Through examples, some of the challenges and opportunities for precision livestock management will be discussed.

Water use efficiency indicators for variable rate irrigation of variable soils

C.B. Hedley^A, I.J. Yule^B, S. Bradbury^C, D. Scotter^D, I. Vogeler^E and S. Sinton^F

^A Landcare Research, Massey University Campus, Palmerston North, New Zealand

^B NZ Centre for Precision Agriculture, Massey University, Palmerston North, New Zealand

^C Precision Irrigation, 581 Taonui Rd, RD5, Feilding, New Zealand

^D Institute of Natural Resources, Massey University, Palmerston North, New Zealand

^E Grasslands Research Centre, Private Bag 11008, Palmerston North 4442, New Zealand

^F Plant and Food Research, Private Bag 4704, Christchurch, New Zealand

Corresponding Author: hedleyc@landcareresearch.co.nz

In New Zealand, over the last decade, at least 3000 centre pivot and lateral sprinkler systems have been installed. 326,313 ha is now under spray systems, composing 74% of all irrigable land. These systems often traverse highly variable soils (e.g. the sandy and stony soils of the Canterbury Plains), applying uniform rates of irrigation to large areas; so studies were initiated to investigate the potential benefits of variable rate modification of these systems (Bradbury, 2009; Hedley and Yule, 2009). This modification fits each sprinkler with a latching solenoid valve which is either pulsed on or off by a node (Bradbury, 2009). The node is part of a wireless control system. Each node operates four sprinklers with individual control of valves; and receives wireless inputs from a central controller to guide variable water delivery. Uptake has been for several reasons, and once installed these variable rate irrigation (VRI) systems have multiple benefits including control of soil water status in the optimum range for plant growth.

We assessed the potential benefits of variable rate irrigation (VRI) on variable soils at five sites where centre pivots irrigate pasture, maize grain or potatoes:

- Site 1: 156 ha Manawatu pastoral site on alluvial and high terrace loessial soils;
- Site 2: 40 ha Canterbury dairy pastoral site on alluvial outwash gravelly soils;
- Site 3: 22 ha Manawatu maize grain crop on sand plain and dune soils;
- Site 4: 35 ha Manawatu maize grain crop on alluvial terrace soils; and,
- Site 5: 24 ha Ohakune potato crop in mixed volcanic air-fall and water-borne tephric soils.

Soil irrigation management zones have been identified at each site, using on-the-go soil electromagnetic (EM) mapping; with assessment of soil available water holding capacity (AWC) in soil apparent electrical conductivity (EC_a) defined zones. Significant differences in zone AWC were found at all sites. Soil AWC was related to soil EC_a at Sites 1-4 ($R^2 \geq 0.8$), so that prediction models could be developed to produce soil AWC maps. At Site 5, a field investigation of the EC_a -defined soil zones revealed three distinctly different soil parent materials in a complex soil pattern of air-fall and water-borne volcanic materials. At this site, no relationship was found between soil EC_a and soil AWC, but soil AWC was significantly different between zones, so that zone management could be used for irrigation scheduling.

We have used a soil water balance model to hypothetically schedule irrigation events for a four year period (2004-2008). Uniform rate irrigation (URI) applies irrigation to the whole field when the critical soil moisture deficit (CSMD) of the smallest AWC zone is reached. VRI scheduling calculates the CSMD for each soil irrigation management zone so that irrigation is applied to different zones on different days. Both URI and VRI are maintaining soil moisture at or above CSMD, and therefore aim for potential yield. VRI makes best use of stored water and intermittent rain events, maintaining a greater SMD.

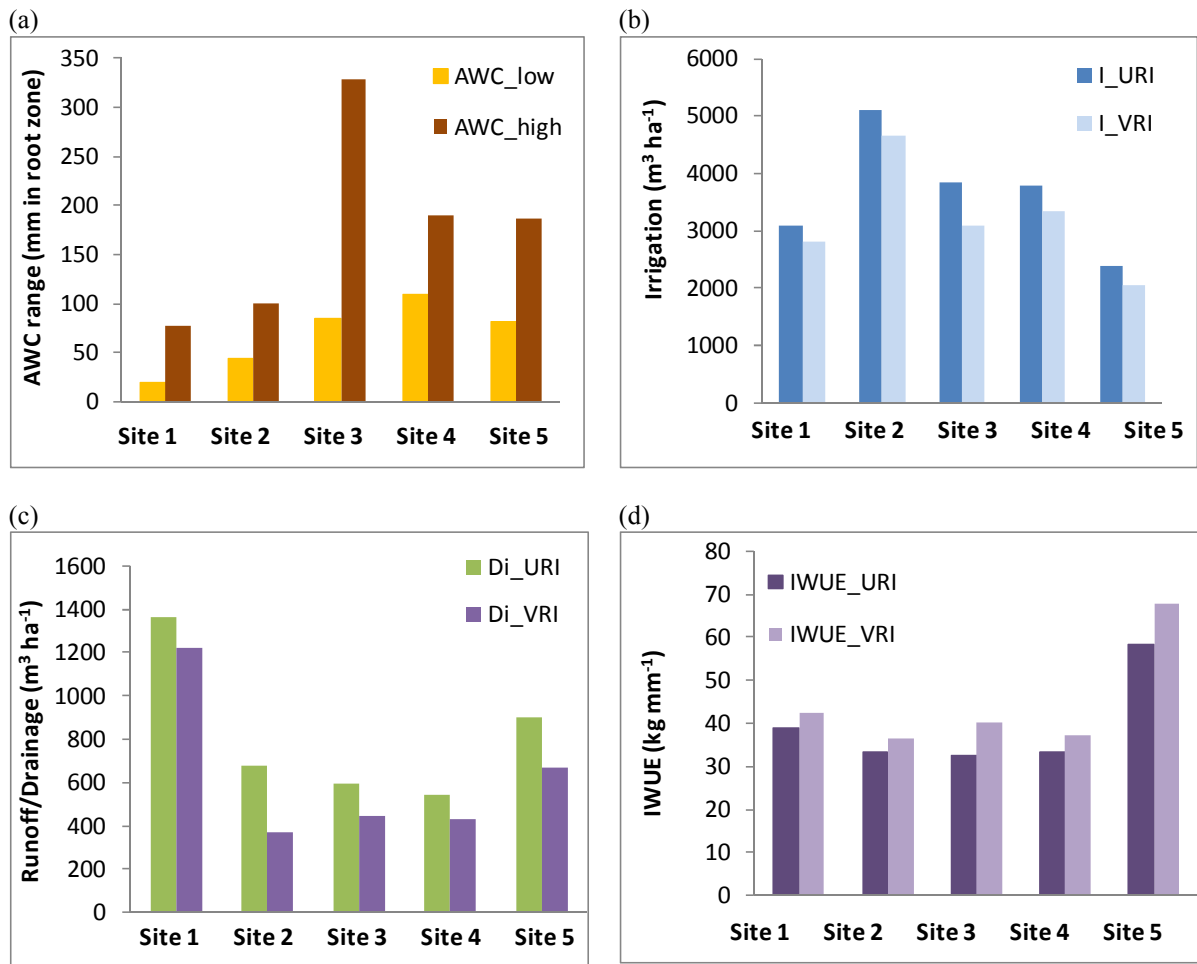

Figure 1. Graphs to show (a) the range of soil AWC under each irrigation system, and to compare WUE indicators for VRI and URI at the 5 case study sites by (b) irrigation water use in one season ($\text{m}^3 \text{ha}^{-1}$), (c) runoff and drainage during the period of irrigation ($\text{m}^3 \text{ha}^{-1}$), and (d) IWUE in one season (kg mm^{-1}) [mean of 4 seasons: 2004-2008].

The following water use efficiency indicators were estimated to compare URI and VRI:

- Amount of irrigation water used in one season ($\text{m}^3 \text{ha}^{-1}$);
- Amount of drainage and runoff during the period of irrigation ($\text{m}^3 \text{ha}^{-1}$);
- Cost saving (based on $\$2 \text{mm}^{-1} \text{ha}^{-1}$ which is estimated to be a realistic typical cost for irrigation in New Zealand at present);
- Irrigation water use efficiency (IWUE) which is calculated as the kg of increased dry matter production per mm of irrigation water applied. Actual or typical regional yields have been used in this calculation (Manawatu pasture: 7 (non-irrigated) to 12 (irrigated) T DM production $\text{ha}^{-1}\text{yr}^{-1}$; Canterbury dairy pasture: 10.5 (non-irrigated) to 17 (irrigated) T DM production $\text{ha}^{-1}\text{yr}^{-1}$; Manawatu maize grain: 6 (non-irrigated) to 12.5 (irrigated) T DM $\text{ha}^{-1}\text{yr}^{-1}$; Ohakune potato crop: 8 (non-irrigated) to 14 (irrigated) T DM $\text{ha}^{-1}\text{yr}^{-1}$);
- Energy use is calculated as $\text{CO}_2\text{-eq m}^3$ of irrigation water applied. A factor of 0.50kWh m^{-3} irrigation water applied is used based on data reported in New Zealand literature. The conversion factor of 0.18 is then used to convert kWh to $\text{kg CO}_2\text{-eq}$ based on the New Zealand Ministry of Economic Development implied emission factors for electricity generation and consumption; and,

- Nitrogen leaching was estimated at three sites using the nutrient budgeting model Overseer Version 5.4.3 (AgResearch®, 2009) for pasture; and biophysical models AMAizeN (Li, 2006) and The Potato Calculator, (Jamieson et al., 2004). These models simulate crop growth using site-specific climate, soil and crop production inputs; with N leaching below the root zone (kg N ha^{-1}) being one output. The depth of the root zone was set at 0.6 m for pasture, 0.7 m for potatoes, and 1.5 m for maize.

Our analysis shows that VRI enabled mean annual irrigation water savings over a 4-year period of 8–21%, with an accompanying energy ($23\text{--}67 \text{ kgCO}_2\text{-eq ha}^{-1}$) and cost saving (NZ\$51–\$150 $\text{ha}^{-1} \text{ yr}^{-1}$). Loss of water by runoff and drainage was reduced by 19–55% during the period of irrigation, which reduces the risk of nitrogen leaching, supported by our modelling results of N leaching under pasture (29 kg N ha^{-1} [URI]; 26 kg N ha^{-1} [VRI]) and potatoes ($11.9 \text{ kg N ha}^{-1}$ [URI]; 9.4 kg N ha^{-1} [VRI]). VRI improved irrigation water use efficiency (IWUE) at all sites (potatoes 58 kg mm^{-1} [URI] and 68 kg mm^{-1} [VRI]; maize grain $32\text{--}33 \text{ kg mm}^{-1}$ [URI] and $37\text{--}40 \text{ kg mm}^{-1}$ [VRI]; pasture $33\text{--}39 \text{ kg mm}^{-1}$ [URI] and $37\text{--}43 \text{ kg mm}^{-1}$ [VRI]), (Figure 1).

The direct benefits of VRI due to soil differences are a starting point for improved water use efficiency, because VRI enables further water savings, such as shutting off water to exclusion areas (e.g. ditches, farm tracks, wet hollows), variable irrigation of different crops under one irrigation system or one crop at different growth stages, better control of water applied at either end of the pivot, as well as site specific fertigation and chemigation.

In New Zealand, irrigation energy costs are about 50% of on-farm energy costs to the farm-gate in dairy farming systems and 39% in arable and vegetable growing systems (Barber and Pellow, 2005). The energy saving benefits of VRI can be increased by ensuring the accuracy of delivery by the irrigator is optimised through regular maintenance. For example, improving the precision of application from 70% to 90% is reported to reduce water and energy use by 30% (Barber and Pellow, 2005).

Saved water can be diverted elsewhere when total water allocations are restricted allowing improved overall on-farm IWUE.

Increased dependence on irrigation for global food supply, and reduced availability of the global freshwater resource requires irrigation systems to become increasingly more efficient. This efficiency can be measured as a dry matter return from each scheduled irrigation event, assessing efficiency of irrigation water use by the plant. Variable soils require variable timing and placement of irrigation for most efficient water use, and existing sprinkler centre pivot and lateral systems are well suited to modification for variable rate irrigation. In addition these VRI systems can be automatically controlled via a wireless node system, from a central controller, with the capability to receive soil water status maps, for automated irrigation scheduling.

References

- Barber, A. & Pellow, G. 2005, 'Energy use and efficiency measures for the New Zealand arable and outdoor vegetable industry', Prepared for Climate Change Office and Energy Efficiency and Conservation Authority, published by Agrilink, NZ, October 2005, 30pp.
- Bradbury, S. 2009, 'Variable rate irrigation for centre pivot and linear move irrigators', retrieved 12 June 2009, www.precisionirrigation.co.nz.
- Hedley, C.B. & Yule, I.J. 2009, 'Soil water status mapping and two variable-rate irrigation scenarios', *Precision Agriculture* 10, 342–355.
- Jamieson, P.D., Stone, P.J., Zyskowski, R.F., Sinton, S. & Martin, R.J. 2004, 'Implementation and testing of the Potato Calculator, a decision support system for nitrogen and irrigation management', in *Decision Support Systems in Potato Production*, eds D.K.L. MacKerron & A.J. Haverkort, Wageningen Academic Publishers, pp. 85–99.
- Li F.Y., Jamieson, P.D., Pearson, A. & Arnold, N. 2007, 'Simulating soil mineral nitrogen dynamics during maize cropping under variable fertiliser management', in *Designing Sustainable Farms: Critical Aspects of Soil and Water Management*, eds L.D. Currie & L.J. Yates, Occasional Report No. 20, Fertiliser and Lime Research Centre, Massey University, pp. 448–458.

Ord Irrigation Area – a diversity of precision agriculture applications

J.B. Medway^A, J.L.Lucas^A and S. Silvester^B

^A Terrabyte Services, WaggaWagga, NSW , Australia

^B Ord Irrigation Pty Ltd., Australia

Corresponding Author: jmedway@terrabyte.net.au

The Ord Irrigation Area comprises 14,000ha of highly productive irrigated land in the East Kimberly region on the border of Western Australia and the Northern Territory. The region produces a range of high value crops including Hybrid Sorghum/Maize/Millet and Sunflower seed, Chick Peas, Chia, Rock Melons, Water Melons, Pumpkins, Belotti and String Beans as well as a variety of tree crops such as Mangoes, Grapefruit and Indian Sandalwood.

Since 2006, Terrabyte Services has been working with a group of agricultural, horticultural and forestry producers, The Western Australia Department of Agriculture and Ord Irrigation investigating a range of spatial information applications within an NLP funded project. Having demonstrated the use of yield monitoring, electromagnetic surveying, remote sensing, soil moisture monitoring, soil sampling and crop monitoring techniques, the individual growers are now adopting the different technologies as appropriate for their specific operation.

As for most agricultural regions, there is significant variability within individual fields that result in substantial production and profitability outcomes.

With the diversity of production types and often no more than two or three producers of individual crop types, the growers and consultants of the region are working collaboratively to share costs and co-ordinate activities to maximise the information generated in a very remote part of the country.

To date, regular satellite imagery has been the core activity of the project with producers using it to monitor crops and target field investigations. With the intensive nature of much of the production, the time management improvements associated with crop/tree monitoring have been found to more than justify project costs with agronomic improvements the focus of the current season activities.

This presentation will discuss the impact of variability within the range of production systems being monitored, discuss the changes to management that have been successfully implemented and highlight a spectacular agricultural landscape.

Producer Perspectives of Precision Agriculture

R. Heath

“Milroy”, Gunnedah, NSW 2380, Australia

Corresponding Author: richtam2@bigpond.com

Richard manages the cropping enterprise of a family farm near Gunnedah on the Liverpool Plains. Durum wheat is the farm’s main source of income; however bread wheat, barley, faba beans, canola, sorghum, corn and sunflowers are also grown. An expanding cattle business is also in operation. Richard travelled on a Nuffield Scholarship in 2003, looking at nitrogen use efficiency, and has as a result retained a major interest in precision agriculture, looking at variable rate nitrogen inputs and canopy management techniques. Richard currently stands as a board member on the Northern Panel of the GRDC.

A survey of Western Australian farmers on the uptake of precision agriculture: problems, issues and a way forward

R. Mandel^A, N. Metz^B, L. Swift^C and R. Lawes^D

^A Curtin University of Technology, Northam, WA, Australia

^B South East Premium Wheat Growers Association, Esperance, WA, Australia

^C The Liebe Group, Wubin, WA, Australia

^D CSIRO Sustainable Ecosystems, Floreat, WA, Australia

Funded by GRDC project CSA00016

Corresponding Author: r.mandel@curtin.edu.au

We surveyed 97 farmers across the Western Australian wheatbelt to gauge the likelihood that precision agriculture technologies may be adopted more widely. The survey was constructed to gauge farmers' understanding of the existence and causes of variability across their farm, to determine how farmers made decisions to treat zones within a paddock, and to determine the factors limiting the uptake and use of variable rate technology.

The majority of farmers had paddocks in which yield varied by more than 1 tonne/hectare. Most were concerned that low yielding parts of their farm reduced their overall farm profitability, and accepted that much of the variability was not "fixable" and needed to be managed differently. Almost all growers varied inputs between paddocks and believed that they could increase profitability by zoning and varying inputs within a paddock.

Growers, in consultation with agronomists, believed they could identify the yield limiting constraint by using (in order of importance): long term observations (mud maps), soil tests, yield maps, and other PA imagery (EM, NDVI etc.). Variable applications of ameliorants including lime, gypsum and claying were carried out by many of the growers surveyed but this was without GIS assistance. Most growers could see the benefits in fine-tuning the applications based on GIS technology.

Those surveyed indicated a willingness to invest in (a) hardware, as most were already using guidance and yield mapping, (b) remote imagery including EM, NDVI etc., and (c) professional assistance to bring the information together. Many had avoided adopting precision agriculture technologies through either a lack of personal ability, lack of confidence to interpret the information, or a reluctance to accept external recommendations without understanding the basis for those recommendations.

The majority of growers surveyed have collected yield data for up to 5 years. Most have not yet used the information in a meaningful way to produce a full VRT program because of problems with, in order of importance, information collation and interpretation, software/machinery interactions, cost and a lack of technical support. There was a strong level of frustration with machine suppliers' ability to service and support the technology and assist with troubleshooting. Although the new ISOBUS standardized communication systems will reduce this problem, it will take many years for this to filter through the industry. Most growers indicated that they were convinced of the benefits of PA, but lacked the ability and confidence to utilize the information available.

Examining the temporal availability of feed and regional turn-off patterns of cattle in Eastern Australia

G.E.Donald^A, D.J.Miron^A, T. Dyall^A and M.G.Garner^B

^A CSIRO Livestock Industries (CLI), Locked Bag 1, Armidale, NSW 2350, Australia

^B Department of Agriculture Forest and Fisheries (DAFF), Office for the Chief Veterinary Officer, Canberra, ACT 2600, Australia

Corresponding Author: Graham.Donald@csiro.au

Abstract

The purpose of the National Livestock Identification System (NLIS) has been to provide a record of cattle movements using an effective, electronic animal tracking system across Australia. The NLIS provides a database of records for all registered movements of individual cattle Australia-wide from 1 July 2005. The availability of an algorithm to simulate real-time and accurate movements of cattle is critical in the event of a major exotic disease outbreak. Such an algorithm could also be used for forecasting and formulation of policies to manage emerging disease threats. From this study real-time pasture information clearly needs to be incorporated into this model. The NLIS data base will provide the basis for testing and verifying a real-time and forecast cattle livestock turn-off patterns as a precursor to developing a real-time cattle movement simulation algorithm.

Introduction

To put in place measures to manage a major exotic disease outbreak, it is critical to have a good understanding of animal movements from farm holdings. The decision of farmers to move beef cattle is complex and often involves many processes such as historical and contemporary factors, climate forecast, commodity prices, animal type, enterprise and number of animals available and associated off-shore activities. This study has identified some of the significant information required to model the movements of beef cattle. Cattle livestock movements from farm to farm, saleyards, feedlots and abattoirs are now recorded using a geographic coordinated national property identification code (PIC). A national spatial database of PICs was established (Emelyanova et al. 2008), providing the means to assess the daily movements of cattle. The study region for this exercise was set in central to southern Queensland and central to northern New South Wales ('Region 6'), broadly corresponding to ABARE regions 322 and 121. The strategic use of quantitative pasture information is necessary to understand and manage feed resource utilisation for the Australian grazing industries, and has major implication for turn-off patterns and production sectors.

Method

In this study, actual animal movements based on the National Livestock Identification System (NLIS) for 2006 were provided by MLA primarily for a project that modelled emerging disease threats (Miron et al., 2007). DAFF beef region 6 was selected as the study site (Figure 1). Farm locations were geolocated using data provided by individual State authorities. For those States that were unable to supply exact farm locations, a probabilistic Bayesian method called *Weights of Evidence* (Emelyanova et al. 2008) was implemented for the purpose of developing a synthetic national scale dataset of cattle farm locations within Australia. Cattle prices for 2006 were obtained from the National Livestock Recording Service (NLRS). Weekly climate grids were provided by the National Climate Centre Bureau of Meteorology (www.bom.gov.au). Due to the size of the target region and the diversity of beef production sectors the region was subdivided into five zones based on the 2006 rainfall and rainfall decile values and profiles. Seasonal decile data were derived from the average preceding season. The pasture growth rate (PGR[®]) information was estimated from satellite remote sensing and climate models (Hill et al. 2004; Donald et al. 2004). Landgate Satellite Remote Sensing Western Australia provided weekly calibrated composited

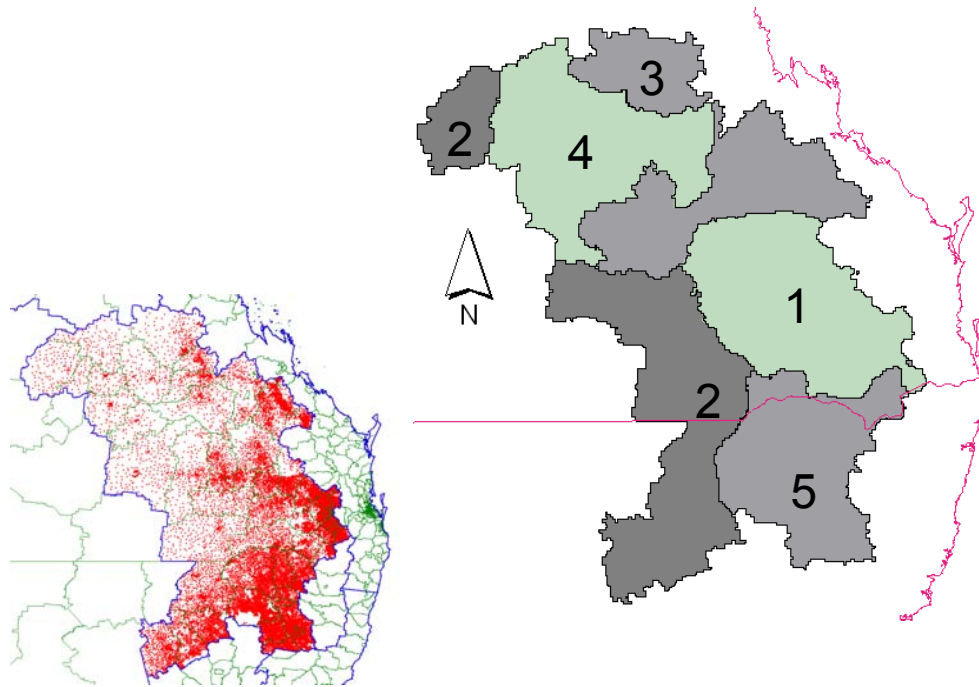

Figure 1. Climate zones and distribution of cattle population within ABARE region 6

Normalised Difference Vegetation Index (NDVI) from the NASA Moderate Resolution Imaging Spectroradiometer (MODIS) sensor data (250m² pixels) obtained from both the TERRA and AQUA earth observation satellites. To derive these climatic zones within beef regions, each region was subjected to an unsupervised classification based on temporal and spatial patterns of total monthly rainfall metrics and every other month rainfall decile rainfalls for 2006. These layers were then subjected to a clustering procedure followed by an unsupervised maximum likelihood classification in a GIS package (Arc/Info ESRI, Australia). Classes were aggregated to final groups using a dendrogram and relative distance statistics. The cattle movements off farm were aggregated into 10 km grids as a means to provide sufficient movements and also, to maintain the confidentiality of individual farm practices. After examining the distribution of cattle moved off farm grids those that did not move more than 150 or exceeded 5000 head of cattle were removed. All data were derived from these 10k grids. The mean weekly mean for each metric and the movements off farm within each climate zone (Figure 1) and were extracted together with other relevant metrics that may assist in understanding the off farm movements of cattle. Weekly Cattle prices by saleyards were provided by the NLRs. The weekly NDVI (greenness) composites were created using a two week 'rolling window' of cloud free maximum-value NDVI at each pixel. The NDVI was calculated as follows from the red and near infrared (NIR) MODIS sensor bands.

$$\text{NDVI} = (\text{NIR} - \text{Red}) / (\text{NIR} + \text{Red}).$$

Weekly pasture growth rate (PGR[®]) information was prepared (Hill et al. 2004) for this region as described by Donald et al. (2004). Feed on offer (FOO) (Ediridinghe et al. 2004) was derived from the 250m² MODIS NDVI using the algorithm of Smiths (Smith et al. 2008). Both the PGR and FOO were designed and calibrated for southern Western Australia and may not reflect true or accurate measurements for Region 6, however, in our view they provide a relative index reflecting the amount of growth and biomass. A perennial remnant vegetation mask (Australian Greenhouse Office, Landsat 7 forest cover data Version 3, released in 2006) was applied to remove all non-farming land from all spatial data layers.

Results

The climatic zones (Figure 1) showed that zones 3 and 4 (Figure 2) have a distinct autumn pasture growing season compared to the other zones with Zone 5 being the most prolific year-round. Two weekly averaged data sets were subjected to a correlation matrix comparing a number of variables to cattle movements (Figure 3) within climate zones (Table 1). Analyses comparing 52 weeks, the first 26 weeks and weeks 27 to 52 are summarized in this table. There were other interesting

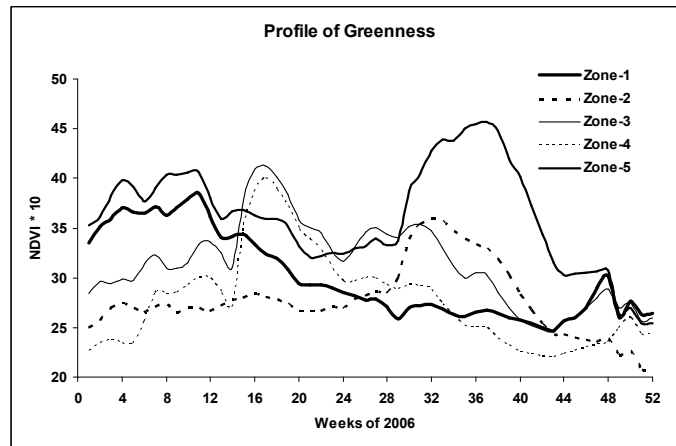

Figure 2. 2006 2 weekly average greenness profile

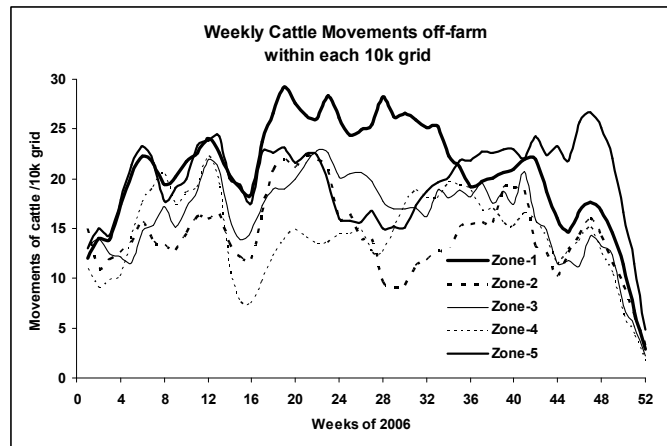

Figure 3. 2006 2 weekly average of cattle movements

associations not described in the correlation table, for instance for the whole year the correlation in zone 1 and 4 between greenness and inferred biomass and off farm cattle movements was not significant but these movements were highly correlated with other climate zones. There are other examples of neighbouring climate zones impacting on cattle movements and as one would expect. Rainfall or the reduction of rainfall had the most impact for 2006. This in turn would have further implications on longer term PGR. Cattle cow price was also of major importance. The spikes in cattle movements (Figure 3) were a reflection of saleyard throughput and the number of buyers present (NLRs).

Discussion and Conclusion

The need to model livestock movements within Australia is of national importance for the purposes of assessing risks associated with exotic disease, and in the event of an incursion for containing and controlling spread. Livestock movement information is also important for infrastructure development and the economic forecasting of livestock markets. Due to the complexity of the reasoning of movements, a complex system science agent-based approach may be the most appropriate means to simulate these livestock movements. The decision of farmers to sell or buy cattle is often complex and involves many factors such as climate forecast, commodity prices, the type of farm enterprise, the number of animals available and associated off-shore effects. The output of such a forecasting system should show the seasonality of beef cattle available for movement off farm and it is envisaged that the NLIS together with cattle prices and contemporary and historical biophysical information will provide the basis to enhance the existing movement model (Miron et al. 2007).

Table 1: Correlation matrix of 2006 climate zones 1-5; 2006= all 52 weeks, S1=first 26 weeks, S2= second 26 weeks. -, **, *, **** reflect negative correlations, yearly 52 observations and 26 for S1 and S2.**

Variable	Zone1		Zone 2		Zone3		Zone4		Zone5				
	2006	S1	S2	2006	S1	S2	2006	S1	2006	S1	S2		
Weekly 10k grid average Cattle	20.0	22.5	17.5	14.1	15.9	12.3	16.0	14.3	14.1	14.4	13.7	19.8	19.4
Moved off farm	****	***	****	.*	*	.*	.**	****	.*	NS	****	NS	NS
Week of the year													
Pasture Growth Kg Dm/ha.day	.*	****	NS	.*	****	NS	NS	NS	NS	.*	NS	.*	NS
Greenness index	NS	.**	NS	*	NS	**	****	*	NS	NS	NS	*	**
Feed on Offer Kg Dm/ha	NS	.**	NS	NS	NS	*	***	*	NS	NS	NS	*	*
Rainfall (mm)	****	****	.**	****	****	****	****	****	****	NS	****	****	NS
Rainfall Decile	NS	.*	*	NS	****	NS	*	*	.*	NS	.*	NS	NS
Seasonal Rainfall Decile	***	**	***	NS	****	NS	NS	***	NS	NS	***	NS	NS
Price Cows	***	*	***	***	*	**	***	***	***	*	***	***	***
Domestic Young Cattle Indicator	***	***	***	**	*	NS	***	***	***	NS	***	NS	NS
Yearling Steers	***	NS	*	NS	NS	NS	*	*	**	NS	**	NS	NS
Feeder Steers	NS	.*	*	NS	NS	NS	*	*	*	NS	*	*	NS

For Year Not significant (NS) < 0.27, * 0.27 - 0.35, ** 0.35-0.44, **** > 0.44
 For Season S1 & S2 NS < 0.32, * 0.32 - 0.48, ** 0.48 - 0.60, **** > 0.60

Results from a survey of producers within region 6 in 2008 (Dyall 2008) suggested that the major drivers to sell cattle were reaching target weight and to meet buyers specifications. Therefore the actual drivers when purchasing cattle were sourcing of suitable cattle, price and pasture availability. These were verified by our analysis. Half of those surveyed sold their cattle at the closest saleyards others were seeking specialist buyers. Financial exposure, commodity prices and pasture availability explained the main considerations to changing the enterprise mix. Our study year 2006 was drought affected with each zone receiving a total average rainfall of 377, 356, 504, 541 and 577 mm/year whereas in 2007 rainfalls of 645, 585, 822, 831 and 698 mm/year, respectively, for zones 1 to 5 were recorded. Therefore, as PGR's were low, an increase in PGR was associated with a decrease in cattle movements and likewise a period of low PGR was associated with an increase in off farm movements.

With the availability of reliable national spatial databases such as climate and long and short term climate forecast ensembles, ABS statistics, census data, elevation, roads, rail networks, and maybe one day NLIS etc., together with the increasing use of GIS and spatial information systems the public, farmers, government and those interested in supply chain structures now have better information to make more informed decisions about managing their livestock. This information also provides the means at the farm, regional and national scale to better plan and manage situations such as exotic disease outbreaks. Also it has applications for sourcing of animals, exceptional circumstance assistance and infrastructure requirements such as provision of saleyards, animal welfare, roads and railheads and retailer supply chain management as examples. From a farming viewpoint these databases allow for re-examination and reassessment of enterprise structures within the farm in light of climate, market and economic shifts to ensure profitability and sustainability.

Acknowledgements

The national model for emerging animal disease threats biosecurity project was funded by the Chief Veterinaries Office, Department of Agriculture, Forest and Fisheries (DAFF), Canberra. The project was grateful to MLA for providing the NLIS database and the NLRS for cattle prices. We wish to thank the continued support of the individual State personnel who took extra time to provide information. We also thank the National Climate Centre of the Bureau of Meteorology for providing the weekly rainfall and rainfall decile grids.

References

- Donald, G.E., Edirisinghe, A., Craig, R., Henry, D.A., Gherardi, S. & Stovold, R. 2004, 'Advantages of TERRA MODIS imagery over AVHRR to quantitatively estimate pasture growth rate in the south west region of WESTERN AUSTRALIA', Aust. Remot. Sens. Photo. Assoc. Conference, Fremantle.
- Edirisinghe, A., Hill, M.J., Donald, G.E., Hyder, M., Warren, B., Wheaton, G.A. & Smith, R.C.G. 2000, 'Estimation of Feed on Offer and Growth Rate of Pastures using remote Sensing', 10th Australian Remote Sensing and Photogrammetry Conference, paper No. 112, Adelaide, Australia, August 2000.
- Emelyanova I.V., Donald G.E., Miron D.J., Henry D.A. & Garner G.M. 2008, 'Probabilistic modelling of cattle farm distribution in Australia', in *Journal of Environmental Modeling and Assessment*. (available online now in press). DOI: 10.1007/s10666-008-9140-z.
- Hill, M. J., Donald, G E., Hyder, M.W. and Smith, R. C. G. 2004, 'Estimation of Pasture Growth Rate in South Western Australia from NOAA AVHRR NDVI and Climate Data', in *Remote Sensing and Environment* 93:528-545.
- Miron D.J., Emelyanova I.V., Donald G.E. & Garner G.M. 2007, 'Agent based model of livestock movements', *International Conference on Complex Systems 2007*, October 28 – November 2, Boston, MA, USA, 2007, <http://necsi.org/events/iccs7/viewpaper.php?id=196>.
- Smith, R., Adams, M., Gittins, S., Gherardi, S., Wood, D., Meier, S., Stovold, R., Donald, G., Khokar, S., Allen, A. 2008, 'Near real-time Feed on Offer from MODIS for the early season grazing management of Mediterranean annual pastures', 14th Aust. Remot. Sens. Photo. Assoc. Conference, Darwin.

Dyall, T. 2008, 'A decision support tool for assessing and managing emerging animal disease threats: Survey of beef cattle producers', A report to the Chief Veterinary Officer, DAFF.

Integration of operational constraints into management zone delineation methods

P. Roudier

Australian Centre for Precision Agriculture, The University of Sydney, NSW 2006, Australia
CEMAGRAPH, France

Corresponding Author: p.roudier@usyd.edu.au

Abstract

In the context of precision agriculture (PA), within-field zoning has long been identified as a privileged means of managing the phenomenon of within-field variability that can appear in a cropping system. The opportunity for applying a zone-based treatment depends on the combination of the intrinsic characteristics of the field with operational constraints related to the machinery used to differentially apply a given treatment. Such constraints can be formulated with the machinery footprint, a maximal number of zones, a minimal zone area, some zone shape attributes, etc. However, those constraints cannot be taken into account efficiently by the classical classification-based zoning approach. This study proposes to introduce a theoretical framework to incorporate operational constraints into management zone delineation methods.

About management zones and classes

Difference between zones and classes

In the context of PA, zoning is a method to manage within-field variability by discriminating management units within a field, i.e. a zoning process splits a field into smaller, more homogeneous and distinct regions. This method may be used either to simplify the spatial representation of the within-field variability, explain reasons for the observed variations, or to provide a simplified way to site-specifically apply a given input. Zoning gives an intermediary representation of within-field variability, between uniform management and continuous site-specific management (Whelan 2001). Managing within-field variabilities using zoning is now a growing practice, and is now considered as the most efficient within-field variability management tool (McBratney et al. 2005).

The existence of numerous scientific articles on this subject illustrates the success of this concept (Vrindts et al. 2005). However, in the existing literature, no distinction is made between management zones and classes (Taylor et al. 2007), despite those two terminologies not referring to the same thing:

- *Management classes* are the result of the clustering of the points showing similar biophysical, pedologic and/or agronomic properties into groups. A management class is composed from the set of points of the field for which a given treatment is required.
- *Management zones* are the spatio-temporal expression of the management classes (McBratney et al. 2005), i.e. the way these groups are distributed in space and time. A management zone is a *contiguous region for which a given treatment is required*.

As a consequence, a management class can express itself in several management zones, while a management zone can contain no more than one management class (Figure 1).

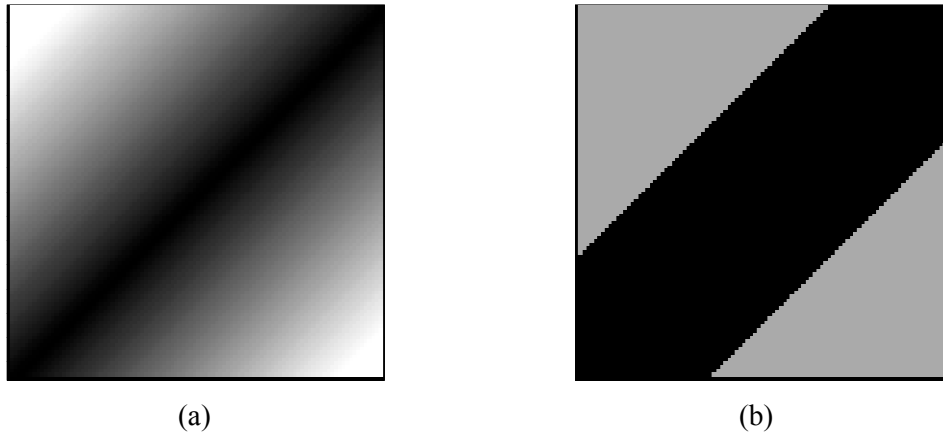

Figure 1. Zoning of a theoretical field into 2 management classes and 3 management zones. (a) Initial data. (b) Zoning result using a *k-means* algorithm with $k=2$.

Operational constraints in PA

The delineation of such zones is subject to different constraints. *Application constraints* are the constraints that are specific to the zoning objectives and to the technical condition of the zoning application. Those constraints can be either related to the data values in each region, or to the morphology of those regions:

Homogeneity: The first set of constraints is related to the way values are dispatched in zones:

- *Intra-zone homogeneity:* Each zone must show a certain level of homogeneity, so that in this zone, the modelling of a spatialized variable by a unique value can be correct.
- *Inter-zone heterogeneity:* At the same time, each zone must be different enough to its neighbours to justify its separation.

Those homogeneity criterion can depend on the considered variable (knowledge on this variable, uncertainties on its monitoring etc.) or on the zoning application that is forsaken (technical possibilities of the machinery).

Morphology: To apply successfully a zoning, the proposed management zones have to fulfil a set of morphological requirements:

- *Area:* The area of the delineated zones must be superior to the area of the minimum technically manageable unit.
- *Number of regions:* An important number of regions require the controller to change the set-points of the input more often, with a raise of the influence of the uncertainties that affect this changes.
- *Shape:* The shape of the delineated zones must be compatible with the machinery that is used to apply the zoning.

Like the homogeneity criterion, morphological criterion depend on the variable, on the application, and on the knowledge one can have on both.

The morphological criterion are opposed with the homogeneity criterion, so that an optimal zoning solution would correspond to a balance between:

- i. Performance of the modelling of the zoned variable by the proposed partition; and,
- ii. The technical ability to apply this partition using given machinery.

Delineating management zones

Management zones are the spatio-temporal expression of management classes. To be successfully applied, zoning should consider homogeneity factors, associated with a set of space-related characteristics (area, number and shape of the zones).

Classification-based methodologies

A major consequence of the confusion between zones and classes concepts is that a majority of zoning tools rely on classification methods. For several reasons, classification methods present characteristics that explain their success in PA. However, some specificities of this process give classification a given number of limitations (Lobo et al. 1996). Classification does not *de facto* incorporate spatial parameters; it is a process of characterisation of individuals based on the comparison of their respective physical values, which not takes into account the spatial disposition of individuals.

Consequences on the quality of the partition

This lack has consequences on the quality of classification results. An important problem affecting per-point classification results is the *salt-and-pepper* effect (Figure 2). The salt-and-pepper effect consists in an important spatial fragmentation of clusters.

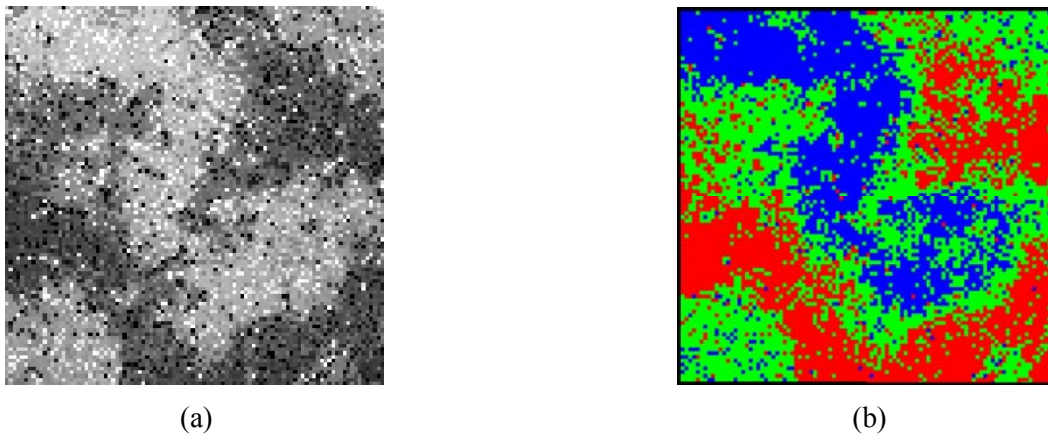

Figure 2. Example of salt-and-pepper effect in classification. (a) Theoretical field. (b) k-means classification of field (a) with k=3 management classes.

In PA, several authors identified the salt and pepper effect has being a major drawback of the existing per-point classification based methods, and noticed the importance to take the spatial information embedded into a data set into account (Ping & Dobermann 2003; Simbahan & Dobermann 2006; Frogbrook & Oliver 2007). In the context of management zone delineation, few methods have been developed to consider the spatial contiguity of the delineated zones: spatial filtering of the classification results (Lark 1998; Ping & Dobermann 2003), introduction of connectedness into a k-means algorithm (Shatar & McBratney 2001), or of variogram parameters (Simbahan & Dobermann 2006; Frogbrook & Oliver 2007). However, those solutions do not represent a satisfactory way to incorporate spatial parameters in the delineation process (Lobo 1997; Simbahan & Dobermann 2006).

Consequences on incorporating operational constraints in PA

The other important limitation of the per-point classification methods is related to the application constraints exposed in Part 1.2. Indeed, the different morphological criterion of the application constraints are by definition related to spatial aspects (minimum area of a zone, number of contiguous zones, shape of a zone). As a consequence, to take it into account, it is important to choose a process that allows the delineation of spatial objects.

By definition, per-point classification is not designed to handle spatial characteristics of a data set, and is therefore not well-suited to the integration of the application constraints. As the integration of such constraints is essential to fully estimate the relevancy of a zoning approach, other methods must be investigated.

Object-oriented approach of management zone delineation

Object-oriented classification

The idea of object-oriented classification is to take into account not only the similarity among data attributes, but also the spatial relationships and interactions between them, in order to lead the interpretation of real world data not only on the comparison of the individual values of data points, but also on the morphology, texture and context of the observed objects. The principle of object-oriented classification is to *segment* the data to be characterised (Ketting & Landgrebe 1976; Lobo 1997). Segmentation is the partition of a group of individuals into spatially coherent entities, with views to their interpretation. As a consequence, the characterisation step is done not on individuals but on meaningful and spatially coherent objects (Figure 3).

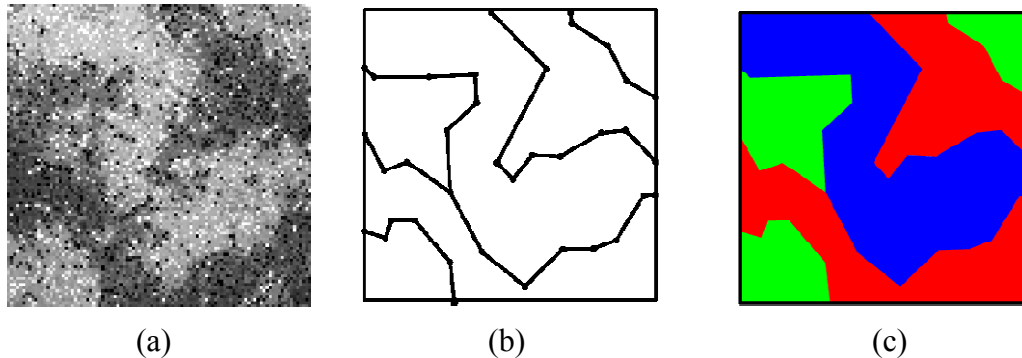

Figure 3. The three steps of object-oriented classification. (a) Theoretical field. (b) Segmentation of field (a) into spatially coherent objects. (c) Characterisation of each delineated object.

This process make use of the fact that segmentation and classification have fundamentally different objectives; segmentation aims at extracting the contours of objects, while classification aims at characterising entities by affecting them to expert or empirical classes. Thus, combining segmentation with classification increases the value of the processed data as each step is providing information that the other one is unable to extract. As a consequence, several authors noticed that object-oriented classification outperforms per-pixel classifiers. Indeed, the characterisation steps is led not on individuals but on coherent sets of points determined by the segmentation step.

Application to PA

In the context of zoning, the segmentation step embedded in the object-oriented strategy allows to introduce variables that are critical when technical aspects of a zoning map are considered:

- It offers a new set of variables to the expert, based on pattern metrics and objects shape (Ping & Dobermann 2003); and,
- It allows consideration of the notion of scale, i.e. number of zones, area of zones, etc.

Thus, the manipulation of variables related to the morphological constraints (area, number and shape of the zones, with regards to the technical conditions of the application) within the delineation algorithm becomes possible (Roudier et al. 2008).

References

- Frogbrook, Z.L. & Oliver, M.A. 2007, 'Identifying management zones in agricultural fields using spatially constrained classification of soil and ancillary data', in *Soil Use and Management*, 23:40–51.
- Ketting, R. & Landgrebe, D. 1976, 'Classification of multi-spectral image data by extraction and classification of homogeneous objects', *IEEE Transactions on Geoscience and Electronics*, GE-14(1):19–26.

- Lark, R. 1998, 'Forming spatially coherent regions by classification of multi-variate data: an example from the analysis of maps of crop yield', in *International Journal of Geographical Information Science*, 12:83–98.
- Lobo, A. 1997, 'Image segmentation and discriminant analysis for the identification of land cover units in ecology', in *IEEE Transactions on Geoscience and Remote Sensing*, 35(5):1–11.
- Lobo, A., Chic, O., & Casterad, A. 1996, 'Classification of Mediterranean crops with multi-sensor data: per-pixel versus per-object statistics and image segmentation', in *International Journal of Remote Sensing*, 17(12):2385–2400.
- McBratney, A., Whelan, B., Ancev, T., & Bouma, J. 2005, 'Future directions of precision agriculture', in *Precision Agriculture*, 6:7–23.
- Ping, J. & Dobermann, A. 2003, 'Creating spatially contiguous yield classes for site-specific management', in *Agronomy Journal*, 95:1121–1131.
- Roudier, P., Tisseyre, B., Poilvé, H., & Roger, J. 2008, 'Management zone delineation using a modified watershed algorithm', in *Precision Agriculture*, 9:233–250.
- Shatar, T. & McBratney, A. 2001, 'Subdividing a field into contiguous management zones using a k-zone algorithm', in *Proceedings of the European Conference on Precision Agriculture*, eds S. Blackmore, & G. Grenier, Montpellier, France, École Nationale Supérieure Agronomique de Montpellier, pp. 115–120.
- Simbahan, G. & Dobermann, A. 2006, 'An algorithm for spatially constrained classification of categorical and continuous soil properties', in *Geoderma*, 136:504–523.
- Taylor, J., McBratney, A., & Whelan, B. 2007, 'Establishing management classes for broadacre agricultural production', in *Agronomy Journal*, 99:1366–1376.
- Vrindts, E., Mouazen, A., Reyniers, M., Maertens, K., Maleki, M., Ramon, H., & de Baerdemaeker, J. 2005, 'Management zones based on correlation between soil compaction, yield and crop data' in *Biosystems Engineering*, 92(4):419–428.
- Whelan, B. 2001, 'Moving to PA management in the grains industry', in *Proceedings of the Geospatial Information and Agriculture Conference*, pages 406–416, Sydney, Australia. NSW Agriculture.

SPAA Producer Groups Update

M. Branson^A and S. Trengrove^B

^A President, SPAA – Precision Agriculture Australia,

^B Grower Groups Co-ordinator, SPAA – Precision Agriculture Australia,
PO Box 83, Strathalbyn, South Australia 5255

Corresponding Author: marknola@activ8.net.au

SPAA/ Producer Groups

SPAA has been running eight producer groups in South Australia since 2007 and have been very successful in helping growers take the next step in PA to using Variable Rate Technologies (VRT).

The grower groups initially had funding from SA Grains Industry Trust (SAGIT), Australian Government Department of Agriculture, Fisheries and Forestry and the National Landcare Program (NLP). The group format has included three meetings per year, including post harvest/pre seeding, mid year, and pre harvest. In 2007, every producer also had the opportunity to set up a PA trial paddock. These trials tested agronomic questions that the growers were faced with including fertiliser and seed rates, alternative fertiliser products, crop varieties, crop row spacing and seed fungicide treatments. Trials were harvested with the farmers' own yield monitor and results analysed for the growers. They were a huge success with many interesting findings coming from them. Best of all they introduced growers to the merits of VRT and gave the growers confidence that Precision Agriculture beyond Guidance would work on their own property.

These Grower Groups:

- Focus grower thoughts on paddock variability;
- Encourage growers to set up trials correctly;
- Help growers use VR equipment to change an input rate;
- Encourage growers to walk into their crop and look at in season variability of their paddock/crop;
- Help growers connect a GPS to their yield monitors and set them up correctly for collecting yield data;
- Make growers collect yield data and download this data to their software;
- Teach growers how to clean up yield data and produce quality yield maps. They also teach growers where incorrect yield data is likely to occur;
- Teach growers how to produce a VR prescription map;
- Teach growers how to load VR prescription maps into seeder controllers and use VR programs; and,
- Teach growers the economics of using VRT.

The uptake of VRT amongst growers was initially slow, but this year there has been a large increase in growers wanting to use their equipment for VR applications of inputs. It is expected that this will continue to increase even more rapidly in the next couple of seasons.

Not only growers have been involved in these groups, but also, agronomists, machinery and service providers, industry people, researchers, journalists and bankers have attended these meetings. A range of experts has been used to deliver information and training. This has included consultants, researchers and machinery people and this has provided a good process for growers to give feedback on machinery, software and research needs to the relevant people.

The real benefit from the groups has been the networking of like minded growers and the rest of the PA industry, which helps solve problems the growers are experiencing.

The future

SPAA has just received a GRDC grant to move PA beyond Guidance for the GRDC's Southern Zone. This project will use existing farming systems groups to deliver the grower group concept to 16 groups in this region. The groups will meet at least three times a year, following a similar format to the existing groups. These will include a post harvest/pre seeding meeting to review the previous years' findings, plan the year's trials and activities and receive training in the use of software and VRT, mid year for a crop walk into the group's trial paddocks and other trial sites, and a pre harvest meeting for header and yield monitor set up training. Each group will have two trial paddocks to answer local agronomic questions and demonstrate to growers that the concepts and best practice of PA and VRT can be adopted in their own local conditions. SPAA will provide training to the groups to ensure continuity of the project between groups. SPAA will administer the project and provide communication between groups as well as publicize the findings from the groups. At the end of the project we hope to have helped the grains industry in the Southern region become proficient in the concepts, use and adoption of PA beyond Guidance and VRT.

GPS livestock tracking workshop papers & abstracts

GPS livestock tracking: an opportunity for a coordinated approach to research, development and extension

M.G. Trotter^A, D.L. Swain^B and D.W. Lamb^A

^A Cooperative Research Centre for Spatial Information, Carlton, Victoria 3053 Australia and Precision Agriculture Research Group, University of New England, Armidale, NSW 2351 Australia

^B CSIRO Livestock Industries, JM Rendel Labs, Ibis Avenue, Rockhampton, QLD 4701, Australia

Corresponding Author: mtrotter@une.edu.au

GPS tracking devices have been available as a research tool for many years, however, their use for livestock research has been limited by the high unit cost coupled with the requirement for adequate distribution amongst a herd or flock. In the last few years the development of low-cost, GPS chips has resulted in a growth of research activity, especially as researchers take advantage of the developments in GPS technology in allied industries, for example mobile phone telecommunications. Simple store-on-board systems have provided the main platform for GPS livestock tracking to date, however there are GPS and telemetry systems currently being developed that will, in the future provide real-time location data and integration with other sensors at a price appropriate for herd/flock-wide deployment in livestock industries.

Unlike other widely-adopted precision agriculture technologies such as yield monitors and electromagnetic soil sensors, there is an opportunity to coordinate a national approach to R&D in GPS livestock tracking before widespread proliferation amongst end-users. There is potential to develop universal protocols which may include standardised reporting criteria such as accuracy testing of GPS devices, proportion of herd/flock sampled and presentation of basic data.

As real-time, remotely interrogateable GPS tracking systems become available, livestock producers will benefit from contemporary information on spatial pasture utilisation, supporting site specific pasture management, scheduling of grazing rotations, feed supplementation and herd health management (e.g. parasite control). Furthermore, monitoring individual animals will enable the generation of Estimated Breeding Values (EBV) that accommodate spatial resource utilisation for genetic selection to optimise production. Researchers need to consider the nature and form of data collected, and post-processing necessary to provide readily interpretable products, for example Livestock Hours Index (LHI) and Dry Stock Equivalent (DSE) maps.

Pasture utilisation and nutrient redistribution in intensively managed dairy systems

I. Draganova^A, I. Yule^B, K. Betteridge^C, M. Hedley^D and K. Stafford^E

^{A, B, D} Institute of Natural Resources, Massey University, New Zealand

^C Grasslands, AgResearch, New Zealand

^E Institute of Veterinary, Animal and Biomedical Sciences, Massey University, New Zealand

Corresponding Author: i.draganova@massey.ac.nz

New Zealand dairy farmers are facing rapidly increasing pressure to reduce nutrient losses from their farming enterprises to the environment. Research suggests that the major sources of nutrient loss is animal excreta, which for nitrogen (N) relates to cattle urine in particular. Most nutrient cycling models assume random distribution of excreta across the paddock. However, non-uniform distribution (e.g. stock camping) is well known and can be caused by contour, water sources, shade and shelter, and on dairy farms particularly, around gateways. It is also probable that areas of the paddock with greater pasture cover and/or higher pasture quality may lead livestock to spend longer in these areas than elsewhere, with the probability that nutrient distribution may be similarly biased. Fertilisers are applied uniformly across the paddock and this in turn leads to over-fertilisation in areas already rich in excreta return. The study aims to provide base line knowledge of how dairy cows utilize pasture and distribute nutrients in regard to field topography, pasture characteristics (e.g. water sources, shelter), pasture mass, and weather conditions.

The study is being carried out on an intensively managed dairy farm at Massey University, New Zealand. Thirty dairy cows are fitted with Global Positioning System (GPS) collars, motion sensors and urine sensors over eight consecutive days. The cows are monitored three times a year at different lactation stages. The Rapid Pasture Meter is used to monitor pasture mass and hyperspectral radiometry is used to map pasture quality within a paddock. This paper reports on monitored dairy cows in late lactation, March 2009. Such knowledge will help farmers develop nutrient budgets, and plan fertiliser and nitrogen inhibitor applications.

Adaptation behaviour of cattle relocated from the rangelands to a temperate agricultural grazing system

D.T. Thomas, M.G. Wilmot, D.K. Revell and R.W. Kelly

CSIRO Livestock Industries, Private Bag 5, Wembley, WA 6913, Australia

Corresponding Author: dean.thomas@csiro.au

This study compared the behaviour and growth of young cattle that were relocated from the Western Australian rangelands to a pasture in a more temperate agricultural region, with animals born and raised in the agricultural region. Ninety five rangeland-raised Brahman-cross heifers (RR cattle) and 122 agricultural-raised Limousin-cross heifers (AR cattle) were transported to the experimental site. Each group was divided into three replicate groups, the RR cattle grazed on pasture plots (n=3) for 12 weeks and the AR cattle grazed plots (n=3) for 8 weeks. Liveweight gain and condition score were measured each fortnight and grazing behaviour was recorded continuously using GPS tracking collars with activity sensors installed. Due to differences in the age and genotype of the two classes of cattle used in this experiment, relationships in growth and grazing behaviour are analysed across time, within each treatment group, and differences in the time-course of behavioural changes between the groups are compared. The RR cattle had reduced liveweight gain during the first four weeks after relocation ($P < 0.001$). From weeks two to four weight gain in RR cattle was 0.31 kg/day, approximately one third of the average daily gain in these cattle for the entire experiment. In contrast, liveweight gain in the agricultural raised cattle remained consistent (~ 1.2 kg/day) during the experiment. During the first six weeks, RR cattle showed behavioural changes indicative of adaptation, including a 61% increase in horizontal head movements (suggesting more grazing activity; Figure 1), 21% more time each day exploring the paddocks, and during daylight hours (0600-1900 hours) they began to travel more (23%) and spent more time active (16%). The AR cattle did not show such a range of temporal changes in behaviour over the first 6 weeks. There was an increase in horizontal (16%; $P < 0.001$) and vertical (12%; $P = 0.002$) head movement in AR cattle, but no other behaviours were significantly affected. We conclude that rangeland-raised *Bos indicus* heifers require from four to six weeks to adapt from their previous large paddocks/natural plant environment to a new temperate agricultural environment and, during this time, RR animals have more exploratory and less grazing activity and liveweight gain. This study demonstrates the improved understanding of factors influencing the productivity and welfare of livestock that is produced by continuous monitoring of livestock using GPS tracking and activity sensors.

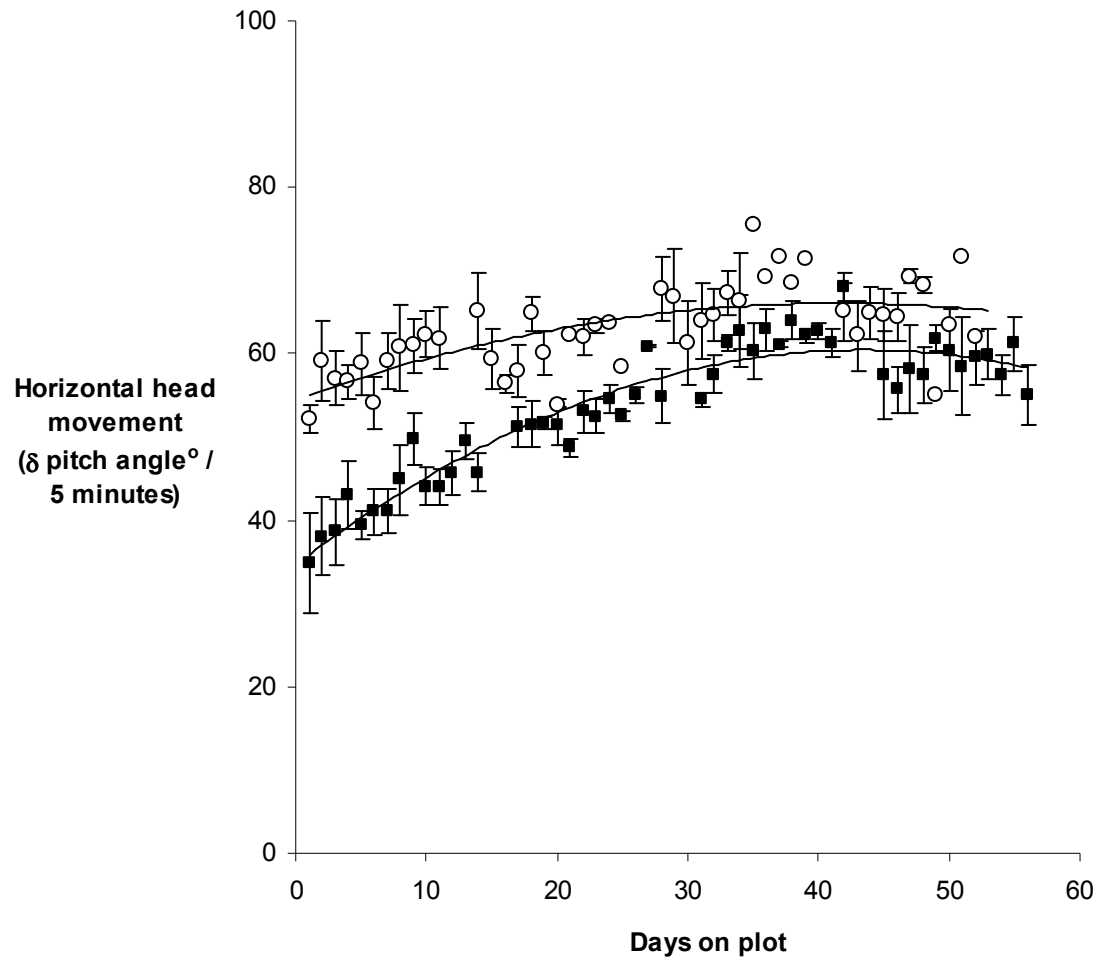

Figure 1. Mean daily horizontal head movement (δ pitch angle $^{\circ}$ /5 minutes) by rangeland raised (■) and agricultural raised (○) cattle after relocation to an agricultural pasture. Error bars are standard errors of the means (n=3).

Sirion, the new generation in global satellite communications: livestock GPS tracking and traceback

G. Stassen

PacRim Satellite Communications, Armidale NSW 2351 Australia

Corresponding Author: gstassen1@bigpond.com

Sirion Global is developing the world's first real time GPS global satellite tracking/traceback system for livestock. The Sirion system (28 LEO satellites) has been in development for over seven years, and will offer affordable cutting edge GPS tracking and traceback, production and farm management capabilities at the press of a button. It will also offer a satellite chip with whole-of-life traceback and production storage capacity.

The design of the Sirion RTU (remote terminal unit) incorporates unique capabilities and advantages over existing technologies used by competitors. The primary advantages over competitor products are the multi-mode transmission functions, including satellite and terrestrial capabilities, the very small size and weight of the unit, the extremely low cost of the terminal and the low cost of services. The specifically designed core chip can be readily incorporated into the customization of the RTU for different market applications. Moreover, the cost will be orders of magnitude lower than competing networks.

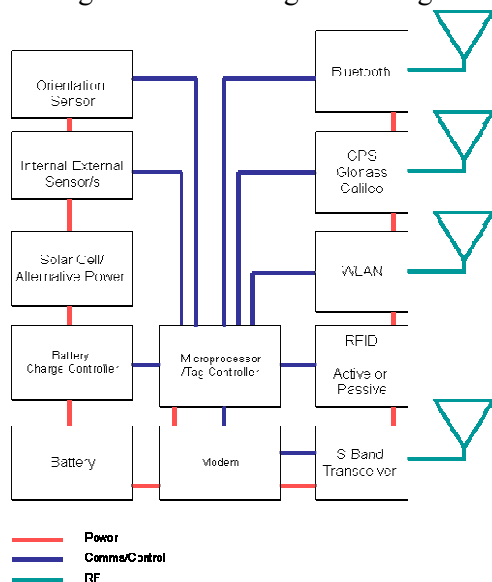

The price for an RTU suitable for fixed or mobile asset monitoring applications is anticipated to be low enough to be able to be given free to volume users. Each RTU will incorporate GPS, S-Band transceiver for communications with the Sirion satellites, UWB (ultra wide band) for medium range terrestrial communications and location, active and passive RFID for close range monitoring, 'Blue Tooth' or similar communications for wireless integration of associated asset sensors, orientation assessment, microprocessor, various micro antennas and power supply. The RTU will incorporate digital software defined radio allowing connection to any RF communication system anywhere.

Governments and major livestock entities around the world are under pressure from both beef export markets and domestic consumers to provide security for the whole supply chain via regulatory authority controls. Only with LEO satellite technology can any real time, effective tracking and traceback system offer the security and response times demanded. This technology, if required, will allow the regulatory authority to complete a national audit within near real time (two to seven seconds). With the press of a button all stock can be GPS located, monitored and restricted or quarantined to specified GPS zones - any movement across proscribed borders (either in or outward) would immediately generate reports to regulatory bodies and/or commercial entities.

The Sirion System and the elements of its Space, Ground, and User Segments, all employ proven technologies and techniques. The uniqueness of the Sirion solution is embodied in its hybrid, integrated design, and in its use of uniquely-held frequencies allocated to satellite tracking, telemetry, and telecommunications.

The Sirion solution also addresses the issue of integration with existing terrestrial infrastructure by employing a tri-mode Terminal Unit with which each animal would be tagged. The design of these units would enable them – in the vast numbers required to support this and other applications – to communicate via: i) the proprietary Sirion Space Segment, ii) and/or

through a purpose-built terrestrial infrastructure suitable for indoor and close-quarters telemetry (i.e. saleyards) and iii) hand-held and locally deployed RFID readers of a type already used in some parts of the world pursuant to existing legislation and regulations.

The Sirion Livestock Solution could be deployed in stages and in such a manner as to be affordable to the end-users, and would not unduly burden either the livestock industry, or Government.

Major weaknesses of current RFID systems are that it is entirely reliant on producer data input and the timeframe taken to do a full traceback audit with data integrity being questionable. Viewing the impact of the US, UK, Canada, Brazil's and Argentina's events and loss of export markets almost overnight, this timeframe will realistically be useless. Their combined BSE and FMD events have now been estimated to have cost US\$35bn – a cost borne by the world's largest beef producers and consumers.

Effective, near real time GPS tracking/traceback is available, virtually at the press of a button. Satellite services will revolutionise the global livestock industry and ensure claims as 'clean, green' suppliers is verified, adding to consumer and government confidence.

The management of animal diseases is an issue of vital importance for all participants in the global livestock industry. A single FMD event can interrupt and halt trade for extended periods - potentially crippling an entire country's livestock sector within a matter of weeks. The flow through impact on that country's economy can be immense.

Although the current RFID system adopted by Australia had set the world standard and was the most appropriate technology at the time of introduction, it is limited and ineffective in achieving its desired outcome. The technology is dated; inevitably cumbersome, extremely time consuming for producers and governments as well as expensive, with major inherent weakness including being solely reliant on producer and service provider data input. History shows that compliance with this type of system is difficult. In both the UK BSE and the recent Brazilian FMD events, producers did not conform to a self governance model of stock movements and the provision of the required data. Livestock movement restrictions in Brazil and neighboring countries were not complied with (let alone enforced or measured), hence recent re-infection / outbreaks. The Sirion Solution will specifically address these critical weaknesses. The Sirion Solution, not relying on labor intense producer input, allows regular audits to be carried out literally 'at the press of a button'; providing total traceback history of the national herd. In addition, the system can notify all stock movements across boundaries of a designated area or property, hence full traceback and continued GPS tracking of stolen or escaped livestock.

GPS functionality within the system translates to effective and near immediate control: the current regulatory requirements are that a producer wishing to move stock from one location to another must first scan his cattle and provide the ID's and movement information to the regulatory authority within 48 hours of the cattle arriving at its new location. This may seem to be a simple function but in fact is time consuming and expensive, particularly for larger herds, e.g. if you wish to move say 300 head of cattle to better pasture on another property the producer would need to scan each beast. With the Sirion system a pen of 300 head can be recorded at a press of a button and within seconds.

Our research showed that producers are moving cattle from property to property without scanning and notifying the regulatory authority. The Sirion system will automatically rectify the problem of unrecorded stock movement (i.e. tracking and traceback). A producer moving livestock across proscribed boundaries, (the GPS coordinates of their property) without the required notification will automatically generates an alert report by satellite readings, rather than being reliant on producer advice or knowledge.

Any movement of tagged livestock across set boundaries, such as suspected infection sites, regions or states generates automatic records of each animal's movement, instantly. Only satellite GPS technology can provide full tracking and more importantly, traceback and quarantine capability.

The real benefits however are not just the tracking and traceback audits. The system also effects containment (quarantine) from external contamination to 'safe' sites. In a hypothetical case, an FMD event on a single property would follow these steps:

1. At the press of a button, the regulatory authority would, via GPS coordinates, quarantine that property for all livestock movement (in or out), or a larger area as defined by the authority – with boundary reporting sent to that authority
2. The authority could - again, at the press of a button and within minutes - generate an audit on a particular beast or herd and its historic movements, animals it had been in contact with or that had visited common sites. Effective containment is achieved in a single day.
3. Effected animals are then treated or destroyed and quarantined areas monitored. The outbreak site/area and quarantined region is therefore restricted and gradually the threat reduced and eliminated. All at the press of a button

If the global beef markets had this system available, it can be argued that their BSE/FMD etc event would have been fully traced and contained; loss of export markets would not have been enacted, as supply could continue from demonstrated safe zones outside strictly defined and enforced quarantine areas. The Sirion system will be the only system that could offer full tracking and traceback.

Poster abstracts

Advances in pragmatic survey of groundwater location and connection with surface waterways

D.A. Allen

Groundwater Imaging Pty Ltd, 279 Fitzroy Street, Dubbo, NSW 2830, Australia

Corresponding Author: David@GroundwaterImaging.com

Electrical conductivity may be imaged pragmatically using geo-electric streamers towed in water or with electromagnetic apparatus towed along the ground or flown through the air. Presented in this poster are examples of how images have been collected from a variety of waterways with different navigation challenges.

In order to interpret the images, 3D presentation in Google Earth has been implemented and this has been augmented by bore lithology graphics obtained by an automatic drillers log interpreter operating on state bore databases. In the example shown at Narromine, these lithology graphics have been used to provide interpretation of a geophysical image along the Macquarie River.

Taking the guess work out of feeding cows

I. Awty

Department of Primary Industries, Victoria, Australia.

Corresponding Author: ivor.awty@dpi.vic.gov.au

It is well recognised within intensive grazing industries, such as dairying, that profit is closely linked to the amount of home grown pasture consumed. Farmers do not want to under-feed high producing cows and this in turn leads to a tendency to overfeed with supplements to maintain production levels. When pasture availability is plentiful, this tendency is also one of the main reasons for allocated pastures being left ungrazed. If just one grazing rotation was considered, it could be assumed that it costs about as much to grow the grass and have it eaten as it does to grow it and waste it.

Over-use of supplements is based on the cattle feeding managers not having faith in the amount of pasture Dry Matter (DM) being allocated or just not making feeding decisions that include the amount of pasture DM being allocated.

In the past there has been time consuming pasture measuring devices available; however, none of them can be left permanently vehicle mounted making them available to be incorporated into every day activities.

The ‘Ellinbank Automatic Pasture Reader’, which consists of an interface display and a sensor, can be left permanently mounted on a farm vehicle and is especially suited to 4x4 bikes. Its working principles are similar that of a bat, in that it emits a series of short sharp “pings” of sound with each echo is separately analysed and if it meets a particular criteria it is then included in the final determination of the average pasture height.

This new technology now makes feeding cows by numbers possible, no matter who does the pasture estimating, allowing supplements to be fed in actual amounts needs to make up for any pasture deficit. The added benefit of correctly allocating pastures means the pasture regrowth is of a better quality and more of it is available to be consumed in subsequent grazing rotations.

If you can measure pasture, you can better manage it!

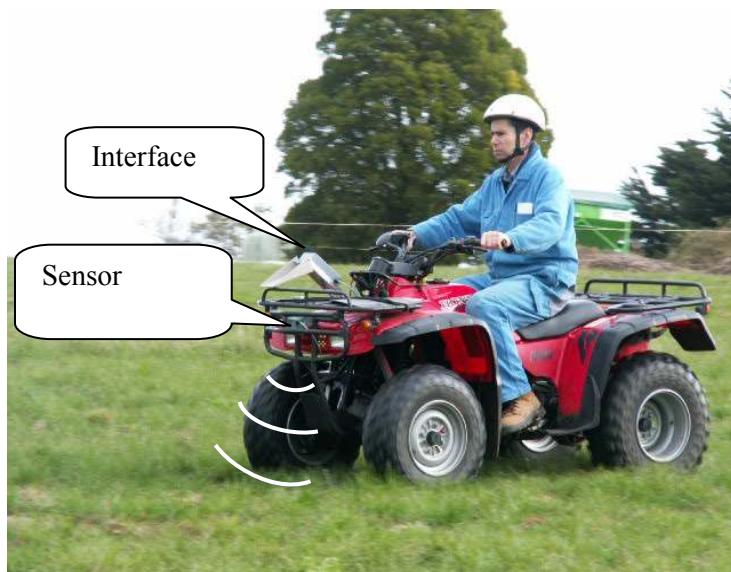

The Reader consists of two physical parts.

(a) The interface (that contains the display and user functions and is connected to the vehicles power supply); and

(b) The sensor head that contains the sound transmitter and receiver, which is mounted to cause the sensors face to be directed at the pasture.

The intellectual property is owned Agricultural Services Victoria (Australia).

GPS-tracking livestock protection animals to improve wild dog management outcomes

G. Ballard^A, P.J. Fleming^B, M.G. Trotter^C and S. Doak^D

^A NSW Department of Primary Industries, Armidale, NSW, Australia

^B NSW Department of Primary Industries, Orange, NSW, Australia

^C Cooperative Research Centre for Spatial Information, Carlton, Victoria 3053 Australia and Precision Agriculture Research Group, University of New England, Armidale, NSW 2351 Australia

^D NSW Department of Environment and Climate Change, Walcha NSW, Australia

Corresponding Author: guy.ballard@dpi.nsw.gov.au

Livestock predation by wild dogs and foxes represents a significant burden on agricultural enterprises in Australia. In addition to wild dog control techniques such as poisoned baiting, trapping and shooting, some landholders have begun to utilise livestock protection animals, including dogs, to reduce the frequency and severity of predation events. In practice, the deliberate addition of large, free-roaming dogs, such as maremmas, to rural environments has provoked apprehension among some stakeholders in wild dog management. In order to inform decisions relating to the use of dogs as livestock protection animals, we aim to fit GPS-tracking collars to sympatric wild dogs and livestock protection animals in north-eastern NSW.

Is pasture really less under the tree? Using an Active Optical Sensor (AOS) to measure changes in pasture around trees in grazing landscapes

P.M. Barnes^A, D.W. Lamb^B and B.R. Wilson^C

^A School of Environmental & Rural Science, University of New England, Armidale 2351, Australia

^B Cooperative Research Centre for Spatial Information, Carlton, Victoria 3053 Australia and Precision Agriculture Research Group, University of New England, Armidale, NSW 2351 Australia

^C Department of Environment & Climate Change, University of New England, Armidale 2351, Australia

Corresponding Author: pbarnes@une.edu.au

Scattered trees are a valuable natural resource, for both above- and below-ground services. However, it has been estimated that within 40 to 185 years, these trees could be lost from the landscape. Without these trees there will be many environmental and agricultural consequences, as is evident by the current degradation in landscapes from where they have already disappeared.

With the continual decline of scattered trees across Australia it is a critical national issue to determine the most advantageous way to sustain them in grazed pastures, in ways that contribute to both agricultural production and environmental enhancement. To date many of these functional attributes have not been examined and consequently stakeholders are unable to make informed decisions about the positive and negative effects of incorporating native vegetation in pasture landscapes.

This research aims to fill these knowledge gaps for the grazing industries on the Northern Tablelands of NSW, helping landholders improve production and profitability in the changing climate of the 21st century. The specific aim of this investigation was to determine how native eucalypt species on different soil types altered pasture biomass around them, as pasture productivity and quality is the single most important attribute for graziers, as it drives the level of attainable production.

On three soil types, basalt, granite and trap, six sites (two per soil type) were selected. Each site contained three mature isolated eucalyptus trees of the same species, with species differing between sites. Using an active optical sensor (AOS) (a CropCircleTM unit – Holland Scientific USA) an area of 3.5 canopy radius (areas ranging from 0.25 to 0.8 ha) was manually mapped in 1m transects with a global positioning system (GPS) around each of the 18 trees. In addition, at each tree along two transects (one across and one down the slope) at 0.25, 0.75, 1.75 and 3.5 canopy radius, three 0.25 m² quadrats of pasture were cut to ground level. Each of these points represents four *zones of influence* around the tree; inner canopy, outer canopy, intermediate and open, with open assuming outside the *zone of influence* of the tree. Each quadrat was separated into 'green' and 'dead' components, dried and weighed to estimate biomass. Pasture biomass was correlated against its NDVI value. The resultant equation was then used to spatially analyse pasture biomass around each tree using ArcGIS Map.

Early results show that biomass (NDVI) changed considerably around trees with no clear indication of *zones of influence* on pasture radiating out from the tree. However, often beneath the canopy higher NDVI values were more concentrated on the southern side under the canopy, and lowest values on the northern. Furthermore estimates of biomass were not significantly correlated with NDVI with R² values ranging from (-) 0.340 to (+) 0.568. This suggests that the use of the AOS to estimate changes in pasture biomass should only be used with extreme caution.

Where are the roots? Can we deduce the edge of a tree's root zone without seeing it?

P.M. Barnes^A, B.R. Wilson^B and D.W. Lamb^C

^A School of Environmental & Rural Science, University of New England, Armidale 2351, Australia,

^B Department of Environment & Climate Change, University of New England, Armidale 2351, Australia,

^C Cooperative Research Centre for Spatial Information, Carlton, Victoria 3053 Australia and Precision Agriculture Research Group, University of New England, Armidale, NSW 2351 Australia

Corresponding Author: pbarnes@une.edu.au

In the Australian environment water shortage is a continual threat to many areas of agriculture within both the cropping and grazing sectors. From this perspective trees within the landscape are often viewed as having a major negative effect, significantly depleting the available surface moisture for crops and pasture, and thus reducing yield potential. This has led to extensive areas of cleared land within the agricultural landscape. However, whilst this effect of trees is 'common knowledge' it has been relatively scientifically unexplored.

Techniques to measure tree water use by individual stems have been well developed. However, these techniques are often expensive, complicated and time consuming, and do not address the changes in soil moisture content around trees i.e. how far out their influence (root zone) extends. A potentially quick and uncomplicated way to address this question is using the tool EM38.

The EM38 tool is an electromagnetic induction sensor which reads conductivity in response to a primary magnetic field. It is designed for examining electrical conductivity quickly in the shallow (< 1.5 m) surface soil without disturbing the soil. Literature has indicated that this measure of electrical conductivity is correlated with soil moisture, enabling an assessment of soil moisture (changes) around trees by reading conductivity. Therefore, this investigation sets out to examine changes in EC / moisture with distance from native trees and to extrapolate expected areas of influence (i.e. presence of roots) on soil moisture based on tree size.

A number of mature native trees on the Northern Tablelands were selected for this study. These trees were multiple species and occurred on multiple soil types. Each tree had their location, soil type, species, DBH, height and average canopy radius taken. At each tree two transects, one across and one down the slope, were examined. EM38 measurements were taken at increments of 0, 2, 4, 6, 8, 10, 12, 14, 16, 18, 20, 25, 30 and 40 m in the horizontal position (depth measured is < 80cm). Data was normalised along each unique transect by dividing each point by the 40m value and then averaging data points across all trees (Y axis). These were then plotted against the average of the unique data point's relationship to the individual tree it belongs to, for example canopy radius (X axis).

Results indicate that when averaged across all trees a significant increase in normalised EM38 value occurs between approximately 0.25 and 1.25 canopy radius from the tree with relatively similar values occurring everywhere outside this area (from 0 to 6 canopy radius). Potentially, this is indicating that beyond 1.25 canopy radius little the tree is have little influence on soil moisture, and therefore its effect on available moisture for pasture growth. However, further work is required to verify this hypothesis.

GPS livestock tracking in wetlands

P. Berney, G. Wilson, D. Ryder and W. Whalley

School of Environmental and Rural Science, University of New England Armidale NSW 2351,
Australia.

Corresponding Author: pberney@une.edu.au

The vegetation communities of the floodplain wetlands in the northern Murray-Darling Basin are highly dynamic in terms of species composition both spatially and temporally. These wetlands have been grazed by European livestock for over 150 years and have always been valued by pastoralists for their fodder reliability and as watering points for stock in a semi-arid landscape. The grazing activities of livestock, however, have resulted on occasions in negative impacts on wetland vegetation, soils and water quality, particularly along the margins of the wetlands. It has been recognized that the severity of grazing related impacts is highly variable, with stocking rate, animal behaviour, geomorphology and wetland water regime all interacting to influence the level of impact. In the published literature there have been few studies on livestock movement in wetlands and to what extent grazing activities are concentrated in particular sites within wetland paddocks.

In this study, GPS collars have been used to monitor cattle movements in a large wetland paddock in the Gwydir Wetlands in New South Wales. The aim of the study was to examine stock movements before, during and after a flooding event and relate patterns of movement to grazing pressure on particular wetland plant communities.

A precision agriculture approach to targeted surveillance for grapevine phylloxera in vineyards

R. Bruce^A, D.W. Lamb^B, J. Runting^C and K.S. Powell^A

^A Department of Primary Industries, Biosciences Division,
Rutherglen Centre, RMB 1145 Chiltern Valley Road, Rutherglen, Victoria, 3685, Australia

^B Cooperative Research Centre for Spatial Information, Carlton, Victoria 3053 Australia and
Precision Agriculture Research Group, University of New England, Armidale, NSW 2351
Australia

^C Grape Advice Pty Ltd, PO Box 413, Balnarring, Victoria, 3926, Australia

Corresponding author: rebecca.bruce@dpi.vic.gov.au

Grapevine phylloxera (*Daktulosphaira vitifoliae* Fitch) is a significant viticultural insect pest worldwide. It is particularly a threat in Australia, with over 80% of grapevines planted on highly susceptible, ungrafted *Vitis vinifera* L. Early detection of phylloxera is critical as it can spread unnoticed in the early years of infestation when visible symptoms in the vine may not be evident. Currently, early detection relies on grid sampling of plant roots to inspect for the presence of phylloxera, and in recent years has included the use of multispectral aerial imagery to identify potentially 'stressed' vines. Whilst the former is labour intensive, the aerial imagery relies on detecting 'weak spots' in the vineyard, which may result from the expression of non-specific (water and/or nutrient related) symptoms, primarily unrelated to phylloxera. Other factors such as healthy canopy vigour may disguise the expression of above ground signs of root degradation.

The dynamics of phylloxera infestation and the often delayed appearance of visible symptoms means current phylloxera detection methods would be improved through development of a 'prediction/risk approach'. Such an approach would be based on biophysical descriptors that directly indicate the potential susceptibility of vineyards to phylloxera infestation. This paper reports on the use of precision agriculture tools to create a grapevine susceptibility matrix-based on spatially-registered measurements. These measurements include photosynthetically-active biomass (PAB) in the vine canopy (GreenseekerTM) and soil electrical conductivity (EC_a) as derived using EM38, chemical fingerprinting (via NMR) of vine leaves, along with direct measures of phylloxera incidence including a soil-based DNA probe and emergence trapping. The project will be conducted in phylloxera-infested vineyards in the Yarra Valley Region (Victoria, Australia) during 2009, 2010 and 2011 seasons.

Integrating spatial data and farmer knowledge to identify causes of spatial variability in grain yield to change management practices

Y.P. Dang^A, A. Smart^B, R. Long^C, B. Sauer^D, R.C. Dalal^E and D. Orange^A

^A Department of Environment and Resource Management, Toowoomba, Queensland 4350, Australia

^B Precision Cropping Technologies, Narrabri, NSW 2390, Australia

^C Elders Moree, NSW 2400, Australia

^D Cotton Catchment and Communities CRC and Precision Agriculture Research Group University of New England, Armidale, NSW 2351, Australia

^E Department of Environment and Resource Management, Indooroopilly, Queensland 4068, Australia

Corresponding author: Yash.Dang@derm.qld.gov.au

Spatial variability in grain yield is common in Australian agricultural field and can range by an order of magnitude across a paddock. The uniform application of inputs to such variable fields not only results in economic losses but also increases the environmental degradation. In general, farmers have the knowledge of the location and size of poor performing areas within the paddock, but rarely understand the causes and consistency of this variability. In this study, we attempted to understand the causes of poor performing areas through a process of integrating farmer knowledge with spatial data obtained using soil and crop sensors.

A 196 ha paddock was selected on a farm near Moree in northern New South Wales. The common soil was grey cracking clay (Vertosol). The farmer had two years of barley grain yield maps (2005 and 2006). We also asked the grower to prepare rough map of the paddock. We obtained information on historical production, nutrient management, frost, weeds and other management practices. Site-specific raw yield data was processed and passed through a routine to provide a clean data set for analysis. Cloud-free images of Landsat (NDVI) were acquired close to the crop anthesis for both the years. Poor performing areas of the paddock were located by integrating clean yield data, NDVI and farmer knowledge. Electromagnetic (EM38) survey was carried out during the wet season in May 2008. Duplicate soil profile samples were obtained from selected locations separately from good and bad areas and analysed for chemical or physical constraints, and gravimetric moisture. Poor performing areas had high concentrations of chloride in subsoil, high nitrate-N in the profile and high exchangeable sodium (ESP), and P and Zn in the surface soil.

During winter 2008, three treatments viz. 0, 50 and 100 kg of starter fertilizer (MAP-Zn) was applied in replicated transects to cover good and poor performing areas. Three C-probes were installed at three locations representing low, medium and high yielding areas. In crop, landsat and airborne images were obtained and finally EM38 survey was carried out after the harvest of barley in October 08, and soil samples obtained from selected locations for gravimetric moisture.

During 2008, mid-season images and grain yield showed variations due to high Cl and ESP, however, there was no significant difference in yield due to the application of different rates of starter P fertilizer. The C-probe data showed that the pattern of water extraction followed the presence of high Cl in the subsoil. In low yielding areas, water extraction was restricted at 30-40 cm soil depth, which coincided with 1228 mg Cl/kg soil; whereas in high yielding areas, roots were able to extract moisture to 80-90 cm soil depth, which coincided with 1240 mg Cl/kg soil.

Profile average apparent EC (EC_a) obtained from EM38 survey in May 2008 (wet profile; representing drained upper limit), had positive relationship with Cl, and soil moisture and this relationship increased with increasing depth of soil sampling. Further, the relationship of EC_a obtained in October 2008 (dry profile; representing crop lower limit) with soil moisture increased substantially as compared to May 2008 survey. The EC_a values had strong negative correlation

with barley grain yield in all three barley crops. This process helped the farmer to understand the causes of spatial variability in the yield potential, which was primarily related to high Cl in subsoil and high ESP in the surface soil and thus, helped to make informed decision to trial different management options, including amelioration and matching fertilizer to the spatial variability of the yield potential within the paddock. As a result, in April 2009, beside starter fertilizers treatments, the farmer initiated the replicated transects of gypsum @ 2.5 t/ha and compost @ 5 t/ha for improving grain yields. There will be different in-crop N treatments determined using crop circle and PAWC measurements using dual EM38.

Preliminary approaches for determining regional scale variability of subsoil constraints in northern grains region

Y.P. Dang^A, R.C. Dalal^B, M. Pringle^B, M. Schmidt^B, S. Darr^A, A. Biggs^A and J. Moss^B

^A Department of Environment and Resource Management, Toowoomba, Queensland 4350, Australia

^B Department of Environment and Resource Management, Indooroopilly, Queensland 4068, Australia

Corresponding author: Yash.Dang@derm.qld.gov.au

Salinity, sodicity, acidity and phytotoxic concentrations of chloride (Cl) in subsoils are major constraints to crop production in many soils of northern grains region of Australia because they reduce the ability of crop roots to extract water and nutrients. Among subsoil constraints, subsoil Cl concentrations had a greater effect in reducing soil water extraction in the subsoil and hence grain yield than did either salinity or sodicity. Subsoil Cl concentration was an effective surrogate for estimating the probability of water extraction from the deeper subsoil layers.

Subsoil constraints vary both spatially across the landscape and within soil profiles. Grid sampling to identify the distribution of possible subsoil constraints, both spatially across the landscape and within the soil profile, is time-consuming and expensive. Recent developments in sensing technologies have shown promise for quantifying soil and crop yield variations both within and between agricultural fields, thus enabled the targeted sampling to monitor and locate areas of potential subsoil constraints, providing both practical and economic advantages.

Two approaches are being evaluated to identify areas suspected of subsoil constraints across different paddocks; (i) single-calibration approach using apparent electrical conductivity, and (ii) multi-year remote sensing of crop yields. To evaluate these two approaches, seven paddocks ranged in size from 198 to 460 ha from a single farm located near Goondiwindi (28° 18' S, and 150° 31' 48' E) in the northern grains region were selected. One of these paddocks (Paddock 15A; 257 ha) was selected for more intensive analysis. Of the soil properties measured, using a linear model, soil Cl concentration contributed greatest to EC_a variability. The coefficients of single calibration model obtained from calibrated paddock (15A) were used to obtain soil Cl concentrations in validation field (15B); the prediction accuracies were between ±10-15% soil Cl concentrations.

For remote sensing, we used historical mid-season normalised difference vegetation index (NDVI), generated from Landsat imagery to simulate cereal grain yield. We used simple approach that the presence of subsoil constraints, especially high subsoil Cl concentrations, can over-predict cereal yield, due possibly to water stress at grain filling. The linear model coefficients obtained in the calibration paddock were used to simulate crop yield for validation paddock. In the western end of the validation paddock, which generally had high concentrations of subsoil Cl and high levels of exchangeable sodium percentage, yield was consistently over-predicted as compared to the eastern end with relatively low levels of subsoil Cl and exchangeable sodium percent. Simulated yield data showed overall classification accuracy of 80% with actual yield data.

Accuracies using both single calibrated EC_a-Cl model and/or multi-year remote sensing were reasonably good, thus providing an opportunity to identify spatial variability of subsoil constraints at farm or regional scale. These approaches will be further validated for other paddocks on this farm as well as 2 paddocks in adjoining farms within 15-20 km on either side of this farm.

Monitoring N deficiency, stripe rust infection and yield in wheat using NDVI

R. Devadas^{A,B}, D. W. Lamb^A, S. Simpfendorfer^C and D. Backhouse^D

^A Cooperative Research Centre for Spatial Information, Carlton, Victoria 3053 Australia and Precision Agriculture Research Group, University of New England, Armidale, NSW 2351 Australia

^B RMIT University, Melbourne, Victoria 3001, Australia,

^C New South Wales Department of Primary Industries, Tamworth, NSW 2340, Australia,

^C School of Environmental and Rural Science, University of New England Armidale NSW 2351, Australia.

Corresponding author: rakesh.devadas@rmit.edu.au

Nitrogen (N) fertilization is crucial for plant growth and development, and yet increased use of N can also result in increased stripe rust severity. The interaction of N application and disease incidence will have a significant bearing on crop biomass evolution and final grain yield achieved and spectro-optical indices like the normalised difference vegetation index (NDVI) can be used to model yield in disease-free crops and this work investigates the performance of mid-season NDVI to predict grain yield in the presence of rust.

Experimental wheat plots comprising different levels of N application, variety and seed treatment for stripe rust disease were established in the consecutive 2006 and 2007 crop seasons in the Liverpool Plains (Northern NSW). Multi-temporal NDVI data were collected using the active Crop Circle ACS-210 (Holland Scientific Inc., NE, USA) and GreenSeeker Model 505 (Ntech Industries Inc., CA, USA) sensors and were analysed in relation to the occurrence of N deficiency, stripe rust infection, biomass and yield.

The multi-temporal NDVI data were found to be highly effective in modelling LAI and biomass generation throughout the growing season. NDVI data collected towards the peak vegetative growth phase of the crop was necessary to model final grain yield in disease free wheat crops whereas NDVI measurements carried out after the peak vegetation phase were found to increase the accuracy of yield modelling in crops infected with stripe rust. As both N deficiency and stripe rust severity exhibited highly significant, negative correlations with the NDVI values it is difficult to separate N deficiency from disease incidence. Indeed the NDVI data was observed to respond more strongly to N deficiency/nutrition than to stripe rust severity.

Vegetation indices for the assessment and discrimination of rust infection and nitrogen deficiency in wheat leaves

R. Devadas^{A,B}, D. W. Lamb^A, S. Simpfendorfer^C and D. Backhouse^D

^A Cooperative Research Centre for Spatial Information, Carlton, Victoria 3053 Australia and Precision Agriculture Research Group, University of New England, Armidale, NSW 2351 Australia

^B RMIT University, Melbourne, Victoria 3001, Australia,

^C New South Wales Department of Primary Industries, Tamworth, NSW 2340, Australia,

^C School of Environmental and Rural Science, University of New England Armidale NSW 2351, Australia.

Corresponding author: rakesh.devadas@rmit.edu.au

Nitrogen (N) is the most important fertilizer element determining the productivity of wheat. However, excessive N availability can heighten the risks of stripe rust incidence. Foliar pigments dominate the visible and near infrared reflectance of photosynthetically-active plant components in crop leaves. N deficiency and stripe rust infection in wheat are both observed to affect the quantity and composition of leaf/canopy pigments. This study set out to investigate the potential of a range of 'popular' narrow-band vegetation indices for quantifying and discriminating between them.

Experimental wheat plots with different levels of N application, variety and seed treatment for stripe rust disease were established in 2007 at the NSW-DPI Breeza Research Station located on the Liverpool Plains (Northern NSW). Spectro-optical reflectance data was collected during two critical stages (Zadoks Growth Stage 47 and 75) of crop season using USB 2000 (Ocean Optics, FL, USA). N deficiency and stripe rust severity were visually estimated using standard scale measurements.

Analysis of the data indicated that vegetation indices based on the 530-550 nm wavelength range was superior in estimating different levels of stripe rust incidence whereas the near infrared (NIR) wavelength region (705-750 nm) was observed to be the best indicator of N deficiency. The ability of vegetation indices such as the Physiological Reflectance Index (PhRI) and Leaf and Canopy Chlorophyll Index (LCCI) to contrast these two wavelength regions makes good candidates for discrimination and modeling stripe rust infection and N deficiency when applied in sequence.

Soil strength ... a useful parameter for mapping management zones

W.K Gardner^A and S. Howard^B

^A WestVic AgServices, 1004 Nth Grampians Rd, Laharum, Victoria 3401, Australia

^B Tain Electronics, Melbourne, Victoria, Australia

Corresponding Author: wvicag0001@bigpond.com

Soil strength is a useful parameter for mapping zones in paddocks. For example, it takes less force to draw a tyne through a sand than a clay, or through a friable soil as compared to a hardsetting one of the same texture.

A system was designed in which soil strength can be logged at sowing or during summer weed control cultivation. This can be done by measuring:

- The force on a tyne (a strain gauge is fitted to the tyne); and,
- The down force on a presswheel (strain gauge or pressure sensor)

Most sowing operations take place at a constant speed, and at a constant depth which ensures these forces reflect soil strength.

The “Soilseeker” has been designed as a stand-alone unit. It can be mounted onto an airseeder or combine, turned on, and requires no further attention from the farmer. These units are hired out at a fixed price per ha of actual mapping carried out.

Examples from the 2009 season will be presented and where possible compared to other parameters such as yield maps or EM38 surveys.

Varirate - an add-in for Arcpad to implement variable rate applications

W. K. Gardner^A and S. Howard^B

^A WestVic AgServices, 1004 Nth Grampians Rd, Laharum, Victoria 3401, Australia

^B Tain Electronics, Melbourne, Victoria, Australia

Corresponding Author: wvicag0001@bigpond.com

A program has been written which operates within ESRI Arcpad which enables commands to be sent in a variety of formats. The program detects current position from GPS, determines which feature in a polygon shapefile it is currently in, and looks up the value assigned to that feature in a specified field. It then consults an intermediate file which determines the appropriate string which should be sent via the RS232 COM port.

The string contained in the intermediate file can either be in ASCII format or ASCII code, thereby allowing the transmission of unprintable characters required by some controllers. A lookahead function (specified in seconds, but calculated as current speed by that time) can compensate for the time taken for machinery to respond to commands. Port settings (baud rate, stop bits etc) can be specified under the auxiliary options in Arcpad. A cost effective electronic controller for electric actuators has also been developed which interfaces with this system, which incorporates error checking via potentiometers on the actuators. The system has been used successfully with a variety of controllers (eg Raven, Bogballe, Amazone, Hardi)

PA tools and soil carbon inventories of farmscapes

E.B. Garraway, M. G. Trotter and D.W. Lamb

Cooperative Research Centre for Spatial Information, Carlton, Victoria 3053 Australia and
Precision Agriculture Research Group, University of New England, Armidale, NSW 2351,
Australia

Corresponding Author: egarraw2@une.edu.au

The value of soil carbon in terms of soil health and production benefits is widely recognised in agricultural systems. However, carbon and biomass are quickly becoming valuable commodities in their own right, as seen by emerging carbon trading schemes. While the coverage of agriculture under any emissions trading scheme is uncertain, the agricultural community are positioning themselves in readiness for such a scheme. A total farm carbon (TFC) map, providing an inventory of above- and below-ground carbon stocks, offers farmers and producers a useful management and decision making tool as they consider carbon emissions and sinks.

Numerous models and calculators have been developed for estimating greenhouse gas emissions, with few also considering carbon sinks. However, many models are restrained by their adherence to GHG accounting methodologies determined by national and international standards or rely on broad-scale state and national data. These tools ignore both site specific conditions and the clear need expressed by farmers for accurate whole-farm carbon audits which include both carbon sources and sinks. Conventional methods for determining both soil and biomass carbon are time consuming and costly.

A case study, established on a UNE grazing property located on the Northern Tablelands of NSW, is being used to test the hypothesis that information derived from ‘conventional’ precision agriculture tools may be combined with other, possibly freely-available data (for example from land management agencies) to create accurate farm-scale soil carbon inventories. It is proposed that a suitable model may be inverted for an *a priori* stratification of farmscapes to guide soil C sampling. A comprehensive dataset including radiometric (gamma ray spectroscopy), multi-temporal soil electromagnetic induction (EM38), under storey biomass (using CropCircle™ sensors), gross land use classification, a soil map, digital elevation model and aerial photography has been collated. Supervised classification was imposed on the dataset to create real-time “carbon landscape units” and regression analyses conducted to determine correlations between the derived landscape units and soil organic carbon as measured from an array of soil cores.

For landscape units on the mid- to lower-slopes, soil carbon was found to be moderately correlated with multi-temporal EM38 and Thorium (radiometric) count data (R^2 0.50). A second tiered classification based on land use (open paddock and treed areas) increased the correlation (0.60 and 0.98 respectively). Preliminary results suggest the application of airborne or satellite sensor-derived products may not only strengthen the robustness of the farmscape stratification process, but may also create a farm-scale carbon map which considers both above- and below-ground carbon stocks.

Precision Management of Merino Sheep

K.G. Geenty^A, G.J. Lee^B, K.D. Atkins^B, A.J. Smith^A and M.A. Sladek^B

^A Cooperative Research Centre for Sheep Industry Innovation, University of New England,
Armidale, NSW 2351, Australia

^B Cooperative Research Centre for Sheep Industry Innovation, NSW Dept of Primary Industries,
Orange NSW 2800, Australia

Corresponding Author: kgeenty@une.edu.au

The development of semi-automated and remote walk-over-weighing systems for differential management of pregnant Merino ewes to maintain maternal body weight is outlined. Radio frequency eartags were used for automatic tag reading and data capture. The animals were weighed twice weekly using fixed weighing with an autodrafter as well as having access in parallel to voluntary walk-over-weighing. Incorporated was an algorithm for prediction of individual pregnant ewe maternal body weight (live weight less weight of conceptus and fleece) and determination of auto-draft instructions for targeted feeding of lupins to individual ewes according to live weight targets. Ewe maternal body weights derived from the algorithm showed 5.7 kg less decline during pregnancy days 40-120 in precision managed ewes compared with controls. About 80% of the ewes used voluntary walk-over-weighing during days 40-120 of pregnancy indicating potential for a fully automated remote system. Improved precision of ewe live weight data from remote walk-over-weighing was achieved using data from a commercial rangeland enterprise. Variance in repeated ewe live weights was reduced by 91.6% with use of a Weight Matrix which eliminated inaccurate weights due to erratic passage over the weighing scales. Use of the semi automated fixed weighing and autodrafting are considered forerunners to fully automated remote walk-over-weighing systems which will be useful under intensive or rangeland conditions. Such systems will reduce labour and animal stress and will provide valuable animal live weight data for management decisions using the Weight Matrix to improve accuracy for effective precision management.

PICSE – Exciting and encouraging the next generation of skilled agricultural scientists through Precision Agriculture

S.N. Greig^A, B.M. Sindel^A, R.S. Jessop^A and D.W. Lamb^B

^A School of Environmental and Rural Science, University of New England, Armidale, NSW 2351, Australia,

^B Cooperative Research Centre for Spatial Information, Carlton, Victoria 3053 Australia, and, Precision Agriculture Research Group, University of New England, Armidale, NSW 2351 Australia.

Corresponding Author: susanna.greig@une.edu.au

The Primary Industries Centre for Science Education (PICSE) program focuses upon linking tertiary bound science students and science teachers with the worthwhile science based career options within agricultural science and the current scientific research supporting local primary industry production. This linkage is achieved through the PICSE Industry Placement Scholarships offered to selected skilled science students. Professional development events and resources are provided to science teachers to enable the science that supports local primary industries to be included in classroom teaching.

The University of New England's Precision Agriculture Research Group (UNE PARG) demonstrates the application of advanced scientific concepts to measure, analyse, investigate, understand and improve primary industry production. These exciting applications are of particular interest to science teachers and students. UNE PARG is therefore a valuable partner to the NSW UNE PICSE program and to date, has contributed to 5 PICSE events enabling 40 teachers and over 25 selected science students to discover the UNE PARG developments. This has included: hands on sessions investigating technologies developed for improved agricultural production (global positioning systems, airborne and satellite remote sensing, electromagnetic soil survey techniques and proximal active plant canopy sensors); an on-site tour investigating UNE PARG's innovative developmental and experimental work associated with frost protection at the local Peterson's vineyard; five day industry placement for a student offered a PICSE Industry Placement Scholarship. Further to this future UNE PICSE events are planned to continue providing students and teachers with an insight into UNE PARG technologies.

The development of a novel tracking system to investigate horse movement

B.A. Hampson

The Australian Brumby Research Unit, The School of Veterinary Science, The University of Queensland, Australia.

Corresponding Author: b.hampson1@uq.edu.au

Currently available commercial animal tracking units are less accurate than some GPS data loggers designed for personal and vehicle tracking and do not record at sufficiently high frequencies to allow accurate movement tracking of fast moving animals such as horses. The aim of this study was to develop a simple Global Positioning Satellite (GPS) data logger unit from available hardware components suitable for monitoring the distance and movement patterns of domestic and feral horses.

Our data logger was modified from a personal/vehicle tracker and was accurate in capturing horse movement. It was 100% reliable over 384 data logging days. The unit had no sleep mode and collected data at five second intervals. The Unit stored 130,000 data points and had a battery life which could be extended in multiples of 6.5 days. An additional advantage was the low weight of the collar and GPS (450 g), which increased to 700 g when combined with a VHF (Very High Frequency) beacon for recovery of data from feral horses. Data was downloaded via Google Earth to allow visual representation of tracks. The GPS unit software performed calculations to determine daily distances.

The unit was tested on domestic horses in a range of paddock sizes and designs. Average distance moved was greater in larger paddocks. Mares moved 4.7 km/day (range 4.2-5.2 km/day) in the 0.8 ha paddock. The average for the group in the 4 ha paddock was 30% higher (average 6.1 km/day, range 5.8-6.5 km/day). The average for the group in the 16 ha paddock was a further 18% higher (average 7.2 km/day, range 6.7-7.6 km/day). The average for horses kept in the 6 m by 6 m yard (1.1 km/day, range 0.2-1.9 km/day) was only 6% of the average daily distance travelled by the feral horses.

Paddock design did not significantly affect distance. The average of the distances travelled by each horse was greatest in the open paddock design and smallest for the spiral design (ratio of geometric means 0.72, 95% confidence interval 0.55-0.96, $P=0.03$). There was no significant difference in the distance travelled by horses between the open paddock and any other design including the popular racetrack design (ratio of geometric means 0.94, 95% confidence interval 0.71-1.24, $P=0.63$).

Average distances travelled over six days by the three feral horses in a 4,000 ha paddock was 17.9 km/day (range between horses 12.5 to 25.9 km/day). The average for the feral horses was approximately 250% higher than that for the group of domestic mares in the 16 ha paddock and indicates that there are important behavioural differences between unworked domestic horses and feral horses. This is not surprising given the difference in resource availability (feed and water) between domestic and feral horses.

A lightweight GPS data logger, modified from a personal/vehicle tracker and mounted on a collar, proved accurate in measuring horse movement over extended periods. Horses kept in small paddocks are quite sedentary in comparison to their feral relatives. Stabled horses and horses kept in small yards perform very little physical activity. Horse movement is limited to an extent by paddock size. Several popular paddock designs had no significant effect on distance travelled by un-worked domestic horses.

Use of remote sensing to assess travelling effluent-irrigator performance on a dairy farm in New Zealand

J. Hanly, D. Horne and M. Hedley

Fertilizer and Lime Research Centre, Massey University, Private Bag 11222, Palmerston North, New Zealand

Corresponding Author: j.a.hanly@massey.ac.nz

Dairy farms in New Zealand produce large volumes of nutrient rich effluent, which is mostly irrigated to land. Surface runoff and drainage from poorly managed land application of farm dairy effluent (FDE) can contribute to the eutrophication of surface waters. Effective FDE management requires adequate facilities for storage of FDE in winter and spring, and the strategic scheduling of irrigations at application depths smaller than the soil moisture deficit, an approach known as 'deferred irrigation'. The aim of this study was to quantify how system constraints, such as insufficient FDE storage capacity, impact on FDE management and the potential magnitude of FDE losses in drainage on a whole farm scale.

This study commenced in July 2007 and was conducted on a 194 ha seasonal supply dairy farm with an artificially drained soil (mole and pipe) located near Palmerston North, Manawatu, New Zealand. FDE was stored in a two-pond treatment system prior to application onto land with a small travelling irrigator. Global Position System (GPS) and wheel speed sensors were used to track the farm's travelling irrigator for 15 months to assess the efficiency of FDE irrigations. Location and ground speed data, in conjunction with the distribution patterns for the irrigator, were used to determine FDE application depths and the area of land receiving irrigation. This information was compared with soil moisture conditions to determine whether the application depth exceeded the soil moisture deficit on any particular day, so that losses of FDE in drainage could be estimated.

Initial tracking of the travelling irrigator demonstrated that irrigator stoppages were a regular occurrence: when the irrigator stopped, FDE was applied to a single area for periods of up to 12 hours. To minimise this risk, an alert system was developed that automatically turns off the irrigation pump when a stoppage occurs and also sends a cellular phone text messages to farm staff. This automatic shutoff facility has prevented any further irrigator stoppages on the farm.

FDE storage capacity on the farm was approximately 2,000 m³, which was insufficient to enable 'deferred irrigation' to be practised effectively. Irrigator tracking data established that approximately 15,000 m³ of FDE was generated and applied to land during the winter and spring of 2008. A soil water balance showed that the soil moisture deficit was near or at field capacity from late June through to early November 2008. As a consequence, as much as two-thirds of the effluent irrigated during this period was estimated to have been applied in excess of the soil moisture deficit and, therefore, had potential to cause drainage. The use of irrigator monitoring has enabled the consequence of insufficient storage to be quantified and provided evidence for the need to increase storage capacity.

Multi-temporal EMI survey of paddock-scale soil moisture variability

M. Hossain^{A,B}, P. Frazier^C, D.W. Lamb^{A,B} and P.V. Lockwood^A

^A Precision Agriculture Research Group, University of New England, Armidale, NSW 2351, Australia

^B Cooperative Research Centre for Irrigation Futures, University of New England, Armidale, NSW 2351, Australia.

^C Eco Logical Australia, Armidale NSW 2350, Australia.

Corresponding Author: mhossai6@une.edu.au

Electromagnetic induction (EMI) sensors have been found to be useful for quantifying paddock-scale spatial variability of soil moisture content. However, most measurements were conducted to monitor soil moisture content at a single point in time rather than examine temporal variability. Modern EMI surveying equipment, when the sensor is integrated with a global positioning system (GPS) and datalogger has the potential to undertake rapid surveys across entire paddocks or larger regions. This paper utilizes the understanding of how EM38 measures volumetric soil moisture content (θ_v) in deep Vertosol soils to explore the potential for multi-temporal EM38 survey to delineate soil moisture zones across the study area. The influence of soil properties on apparent electrical conductivity (EC_a) measurement (unit of mS/m) was tested for non-saline soils and soil moisture found to be most significant factor influencing the EC_a measurements in this soil. The coefficients of variation of moisture content ranged from 2.7 to 2.8% and 3.3 to 3.9% in dry and wet periods, respectively. The spatial pattern of relatively high and low soil moisture areas was fairly stable throughout the survey period where high and low moisture content was found in low and high elevated areas respectively. We conclude that micro-topography in this study area influences the pattern and magnitude of spatial distribution of soil moisture content. The capture and comparison of multiple on-the-go EM38 surveys in this study also showed that soil moisture was the primary driver of temporal variation in the EM38 derived EC_a at this site. Maps of derived θ_v values were correlated to site topography and the inclusion of multi-temporal EM38 survey data gave the most accurate representation of topographic effects (drainage).

A new tool for measurement of spatial variability in vineyards

B. Kerridge^{A,B}, J.W. Hornbuckle^B, E.W. Christen^{B,C} and R.D. Faulkner^C

^A School of Environmental and Rural Science, University of New England, Armidale, NSW, Australia

^B CSIRO Land and Water & CRC for Irrigation Futures, PMB 3, Griffith NSW 2680, Australia

^C School of Environmental and Rural Science, University of New England, Armidale, NSW, Australia

Corresponding author: Belinda.Kerridge@csiro.au

Higher evapotranspiration rates, reduced rainfall and increased water scarcity have led to a need for improved water use efficiency. These improvements can predominantly be made in irrigation water storage and delivery efficiency; however, it is at the field-scale that there is potential for major savings.

Knowledge of spatial variability in vineyards is increasingly being incorporated into harvest, fertiliser and pest/disease management decisions. To improve irrigation efficiency and productivity, vineyard managers should also consider incorporating the spatial variability into their knowledge base. To determine spatial variability, numerous field measurements are needed, which is not only time consuming but costly, therefore there is a need for a rapid assessment technique.

To establish the spatial variation in potential evaporation losses within a 12ha paddock, a quadbike was mounted with sensors to measure: surface soil and canopy temperature, normalised differential vegetation index and canopy size. The results indicate spatial and temporal variation in soil evaporation, which when combined with modelling will provide indications of total evaporative losses. The information obtained from this rapid assessment technique will be useful for the assessment of irrigation design and management practices to minimise evaporative losses.

Design and demonstration of precision agriculture irrigation applied to different vegetable crops

Susan Lambert^A, Frank Hay^A, Tony Norton^A, Bill Cotching^A and Andrew Terhorst^B

^A Tasmanian Institute of Agricultural Research, University of Tasmania, 16 Mooreville Road, Burnie, Tasmania 7320, Australia

^B CSIRO ICT, Castray Esplanade, Hobart, Tasmania 7001, Australia

Corresponding Author: Susan.Lambert@utas.edu.au

A new project commencing in the growing season of 2009 will investigate the use of new technology to improve water and energy efficiency in the Tasmanian vegetable industry. As pressure increases on water resources for agriculture in Australia and global demands for food production increase, it is imperative that water resources are managed effectively and efficiently for crop production. The Tasmanian Institute of Agricultural Research (TIAR) is commencing a project funded by Horticulture Australia Limited in collaboration with CSIRO Information and Communication Technology (ICT) Centre and a Tasmanian irrigation company, Seattle Services Pty. Ltd. This project will investigate site-specific precision irrigation to improve water and energy consumption during vegetable production and will be conducted over three growing seasons (2009-2011). Two commonly used irrigation systems in Tasmanian vegetable production will be used in the project - a linear move irrigator and a big gun irrigator. Although big gun travelling irrigators are considered relatively inefficient in terms of energy and water consumption, and are generally older technology, they remain popular in the vegetable industry due to portability and low capital cost. This project will investigate technology which may be fitted to big gun traveller irrigators to improve both energy and water efficiency. The project will also retro-fit a linear move irrigator with new technology to enable communication with a network of soil moisture sensors across the field (provided by CSIRO ICT) and a decision support system to enable site specific irrigation. A cost-benefit analysis will be conducted to compare the technology to current irrigation practices over a three year rotation of vegetable crops at Forthside Vegetable Research Station, Forth, Tasmania. The overall aim of the project is to provide growers with options which will allow improved water use efficiency, reduced energy costs and reduced environmental impact.

Tactical nitrogen fertiliser for canopy management in wheat – implications for variable rate nitrogen applications

K.G. McMullen^A, B.M. Haigh^A, A.D. Bowring^A and N. Poole^B

^A NSW Department of Primary Industries, Tamworth, NSW Australia,

^B Foundation for Arable Research, New Zealand

Corresponding Author: Bruce.Haigh@dpi.nsw.gov.au

Nitrogen (N) fertiliser for wheat is usually applied “up-front” in the seed bed at sowing. Traditionally, the decision on the rate of application is based on the amount of water and N in the soil at sowing and forecast seasonal conditions. Complete seed bed applications can be under-utilised if there is a dry finish to the season. By applying N fertiliser “in-crop” there is potential to reduce the amount used or to increase N-use efficiency (NUE, yield per unit of applied N). In 2008, two small plot field experiments were sown on the Liverpool Plains to investigate the effect of time and rate of application of N fertiliser to manipulate crop canopy structure and maximise grain yield. The first study examined the response to increasing rates of “up-front” fertiliser. In a second study, the same rate of fertiliser was applied either at sowing, GS-31 or GS-39 growth stages. Intensive measurements of the wheat biomass and reflectance (NDVI) were taken in the growing season to predict grain yield.

Variable rate N fertiliser application, as proposed by Oklahoma State University, has been adopted by many farmers in the USA. It uses the GreenSeeker (N-Tech Industries, Ukiah, CA) sensor to measure the NDVI of the crop across the paddock during the season and compares this with the NDVI from an N-rich strip in the same paddock. The crop is used as an indicator of N fertiliser requirements for that area of the paddock and a top-up rate can be estimated using a “Sensor – Based Nitrogen Rate Calculator”. The calculator is claimed to give a conservative estimate of N requirements of the crop.

During the field studies, above average rains in spring produced high yields with an average grain yield of 4.7 t/ha for “up-front” N treatments. It was possible to delay N fertiliser application until GS-31 and exceed this yield by 19%. These results suggest that relationships between NDVI, in season estimated yield (INSEY) and wheat yield can be defined for Australian conditions and are useful in the Nitrogen Rate Calculator. Depending on the seasonal conditions, there maybe multiple pathways to achieving yield potential by applying fertiliser at strategic growth stages.

Spectral reflectance for the detection of grapevine leafroll-associated virus-3 in white-berried wine grape cultivars

E.M. Perry^A, N.A. Rayapati^B, F.J. Pierce^C and T.Mekuria^B

^A Department of Primary Industries, Horsham VIC, Australia

^B Department of Plant Pathology, Washington State University, Prosser, WA USA

^C Center for Precision Agriculture Systems, Washington State University, Prosser, WA USA

Corresponding Author: eileen.perry@dpi.vic.gov.au

The detection of viruses in plants involves destructive sampling followed by testing by enzyme-linked immunosorbent assay (ELISA) and/or reverse transcription-polymerase chain reaction (RT-PCR). In a previous study, we investigated the potential of leaf spectral reflectance changes between virus infected and uninfected grapevines (*Vitis vinifera* L.) of two red-berried wine grape cultivars (Cabernet Sauvignon and Merlot) toward developing non-invasive techniques for field-based 'real-time' diagnosis of grapevine leafroll disease (GLD).

Specific differences in vegetation indices and wavelength intervals were observed between virus-infected and uninfected leaves in the green peak (near 550 nm), the near infrared (near 900 nm) and in the mid-infrared (near 1600nm and 2200 nm). Results of reflectance spectra and classification analysis suggested that different vegetation indices and/or individual wavelength bands differed in their ability to detect GLD depending on whether there are visible symptoms in the virus-infected leaves. However, even using only non-symptomatic leaves from infected plants, a classification with an overall accuracy of 0.75 was generated. When both symptomatic and non-symptomatic leaves from infected plants were used, the classification results improved to 0.81 for an overall accuracy.

The objective of the present study is to evaluate whether a similar approach would differentiate between virus infected and healthy grapevines in white-berried cultivars, as these typically do not express visual symptoms similar to those observed in red-berried cultivars. In this paper we present initial results from measurements made on Chardonnay grape vines.

Practical remote sensing applications for the peanut, sugar cane and cotton farming systems

A.J. Robson^A, G.W. Wright^C, M.J. Bell^A, J. Medway^B, P. Hatfield^C, and R.C.N. Rachaputi^A

^A Primary Industries and Fisheries, Department of Employment, Economic Development and Innovation, J. Bjelke Research Station Kingaroy, Queensland 4610, Australia

^B Peanut Company of Australia, Haly St., Kingaroy, Queensland 4610, Australia

^C Terrabyte services, P.O. Box 1411, Wagga Wagga, NSW 2650, Australia

Corresponding Author: andrew.robson@dpi.qld.gov.au

Progressive farming coupled with improved spectral resolution, cost and availability of satellite imagery, has seen an increase in the development and adoption of practical remote sensing applications within both Queensland and Papua New Guinea. Research undertaken by the Queensland Primary Industries and Fisheries with industry partners such as Peanut Company of Australia, Bullseye Precision Farming and Landmark Pty Ltd (Australia) and Ramu and Trukai Agri-Industries (PNG), has seen a number of practical remote sensing applications implemented into existing agronomic practices within the peanut, sugar and cotton farming systems.

Although not a new concept, the use of classified NDVI satellite images to identify in-season crop spatial variability and aide in GPS guided agronomic surveys has been readably adopted, particularly in determining the location and extent of cropping constraints such as those resulting for irrigation and drainage inefficiencies or disease and pest outbreaks. In peanut this information has enabled accurate estimates of lost production resulting from under performing regions to be established. Across the three industries, strategic soil nutrient sampling from the high and low vigour crop regions has proven to be a more efficient and representative indicator of soil constraints impacting on crop production than the standard practice of grid soil sampling. In a sugar cane case study this strategic sampling regime reduced the number of sample cores required while enabling localised macronutrient deficiencies such as calcium and potassium to be identified. This result would not have been achieved with the grid sampling method. Similar results have been achieved in cotton and peanut crops, where regions of limited production and high disease incidence have been correlated with a wide array of sub-soil constraints. These results can facilitate improved management strategies such as variable rate fertiliser and targeted chemical applications, rather than the standard blanket applications. This provides savings on input costs as well as time and fuel required for the application.

Yield prediction from remotely sensed imagery is also a well accepted application; however there has been limited use of remote sensing for yield prediction in Peanut. More than six years of yield measurements and corresponding NDVI values, encompassing four growing environments (Kingaroy, Kumbia, Wooroolin, Katherine) and eight short and long duration peanut varieties, has allowed development of an algorithm that has been shown to accurately predict dryland peanut yield. This result is highly beneficial to peanut marketers as estimates of regional production can be made before loads are delivered. Similarly current research on tracking peanut harvest loads from paddock to plate using remotely sensed imagery and GIS has resulted in the possibility of improved traceability, an application of major interest to international consumers.

The collaborative nature of this research, combined with the positive and useful results generated, has resulted in a number of industry partners incorporating remotely sensed imagery as an important tool in their current agronomic management.

Matching inputs to soil variations in cotton farming systems: how far can we push precision agriculture to deliver?

B. Sauer^{A,B}, C. Guppy^B, M.G. Trotter^C and D.W. Lamb^C

^A Cotton Catchment Communities Cooperative Research Centre, NSW, Australia

^B School of Environmental and Rural Sciences, the University of New England, Armidale, NSW 2351, Australia

^C Cooperative Research Centre for Spatial Information, Carlton, Victoria 3053 Australia and Precision Agriculture Research Group, University of New England, Armidale, NSW 2351 Australia

Corresponding Author: brooke.sauer@bigpond.com

Precision agriculture (PA) involves a range of methodologies and technologies which aim to improve the precision of agricultural management in spatially-variable fields. Crop yield monitoring, high resolution aerial imagery and electromagnetic induction (EMI) soil sensing are three widely used techniques in PA. Yield maps provide an indication of the crop's response to a particular management regime in light of spatially-variable constraints. Aerial imagery provides timely and accurate information about crop conditions during the growing season and EMI indicates spatial variability in soil texture, salinity and or moisture content; the output of both tools is often inextricably linked to crop yield. Managers on a cotton farm in northern NSW found a bell curve relationship between yield and apparent electrical conductivity (ECa) where cotton yield is lowest in the extremes of ECa. Irrigation scheduling and nitrogen management are targeted at the majority soil class type which results in excessive irrigation on soils with high ECa as a result of water-logging and water limitations on soil with a low ECa. This research investigates the potential of using a combination of EMI sensing in conjunction with high resolution aerial imagery and differential fertilizer management to optimize the match between spatially-variable plant water demand and plant available water. Results so far suggest that ECa soil class maps as a basis of spatial variability is a useful method to interpret spatially variable water demand in cotton. Additionally the combined analysis of yield maps and high resolution aerial imagery indicates efficacy of soil class management as a function of yield and profit. Results also suggest that variable rate applications of in-season nitrogen can optimize cotton production on alternate soil classes when irrigating for the majority soil class.

A simple field calibration procedure for EM38 units when undertaking multi-temporal surveys

D. Schneider, D.W. Lamb and M.G. Trotter

Cooperative Research Centre for Spatial Information, Carlton, Victoria 3053 Australia and
Precision Agriculture Research Group, University of New England, Armidale, NSW 2351
Australia

Corresponding Author: parg@une.edu.au

Multi-temporal electromagnetic induction (EMI e.g. EM38) surveys of fields may provide a greater insight into soil water dynamics, and when deployed as such may better inform irrigation or fertiliser management with a view to improving water use efficiency. Measuring absolute soil moisture content and subsequent changes over time requires detection of apparent electrical conductivity (EC_a) changes as small as a few mS/m, and this requires an accuracy in instrument calibration and performance that is not achievable by relying solely on 'standard' instrument nulling and calibration procedures. In-field calibration has been reported by other workers as a major factor resulting in high levels of divergence from theoretically modelled responses especially at low conductivity ranges and significant instrument drifts have also been observed in this present work. To this end, a simple and inexpensive calibration rig and procedure has been developed to monitor the gain and offset of EM38 sensors in response to a constant *q-coil* at the beginning and end of each survey. The 'response curve' can be used to derive instrument-specific temperature correction algorithms (assuming the case temperature is monitored and logged during subsequent surveys) and also be used as the basis of a conversion algorithm to correct multi-temporal survey data to a common instrument performance characteristic.

What can sheep teach us about shelter use?

D.B. Taylor^A, G.N. Hinch^A, M.G. Trotter^B, W.Y. Brown^A, I.R. Price^C, E.K. Doyle^A and D.W. Lamb^B

^A Animal Sciences, School of Environment and Rural Sciences, University of New England
Armidale, NSW 2351, Australia

^B Cooperative Research Centre for Spatial Information, Carlton, Victoria 3053 Australia and
Precision Agriculture Research Group, University of New England, Armidale, NSW 2351
Australia

^C Psychology, School of Behavioural, Cognitive and Social Sciences, University of New England
Armidale, NSW 2351, Australia

Corresponding Author: dtaylor2@une.edu.au

Over many years there has been limited success in encouraging sheep to use shelter and a poor understanding of why they choose to use shelter the way they do. Have we misunderstood sheep use of shelter and if so are sheep sensible in their use of existing shelter based on climate and topography? The information gathered in this research should address this question and more. Over three lambing seasons a random sample of five ewes from each of the two flocks of 200 - 300 ewes were fitted with GPS collars. The GPS collars provided continuous (51 days) observation of the ewes' movements and use of shelter in two paddocks with varying shelter designs on a commercial property on the Northern Tablelands, NSW. Weather stations and temperature loggers were strategically located throughout the paddock to provide localized measures of temperature, wind speed and precipitation that will be correlated to paddock and shelter use by the flocks. These data will give insight into sheep choice of shade and shelter use within a paddock relative to climatic conditions post shearing and during lambing. If sheep are reluctant to use perimeter shelter currently provided by producers, can they be encouraged or attracted to shelter during inclement weather?

To determine if sheep could be trained to a visual and/or auditory stimulus that would attract them to shelter, forty-four fine wool Merino ewes were obtained at eight months of age, gentled, introduced to lupin grain and randomly dividing them into four groups (n=11): auditory, visual, visual+auditory and control (not trained). The ewes were trained in a 23.9 x 21.5 m outdoor arena to approach either the auditory, visual or visual+auditory stimulus for a food reward. After eight days of individual training the ewes were tested in a 'T' shaped maze without a food reward. The proportion of correct T-maze choices for each group was: auditory 36% (\pm SEM 0.08), visual 41% (\pm SEM 0.04) and visual+auditory 58% (\pm SEM 0.04). The ewes learned to approach the stimulus within 5-6 trials and demonstrated long-term memory retention for over 110 days without reinforcement. Training significantly improved the animal's ability to choose the stimulus. The controls received no training and made no choice during the 60 second T-maze test. The time taken by the trained animals to make a choice decreased as their proportion of correct choices increased ($p < 0.01$, $R^2 = 0.75$) suggesting memory assurance in making the choice. This study indicates sheep can be trained to approach a visual/auditory stimulus that could potentially be used to attract them to shelter.

The next phase of our research will examine whether Merino synchronized following behaviour can improve the trained sheep's ability to lead a group of naive sheep to the stimulus. No published study has examined a means of attracting sheep to shelter as an alternative to forced shelter provision; or studied shelter use with GPS to understand their shelter selection criteria.

*Scholarship funding from AWET, Sheep CRC and assistance with research funding by UNE, AWI and Precision Agriculture Research Group UNE is gratefully acknowledged.

Interrogation of GPS tracking data to determine spatial grazing preferences of livestock

M.G. Trotter^A, D.W. Lamb^A and G.N. Hinch^B

^A Cooperative Research Centre for Spatial Information, Carlton, Victoria 3053 Australia and Precision Agriculture Research Group, University of New England, Armidale, NSW 2351 Australia

^B School of Environmental and Rural Science and Precision Agriculture Research Group, University of New England, Armidale, NSW 2351, Australia

Corresponding Author: mtrotter@une.edu.au

Yield monitors linked with GPS have revolutionised the grains industry and been one of the key drivers behind the adoption of site specific land management. We suggest that GPS tracking of livestock can provide graziers with data which, when fully developed, may enable them to understand spatial variability in pasture utilisation by their livestock and potentially implement site specific management to account for biomass and nutrient removal and redistribution. This poster reports on an initial trial established to examine the potential of a GPS tracking system developed at the University of New England for determining the spatial variability in resource utilisation of pastures.

The trial site was located at “Newstead”, a property 40km east of Inverell on the Northern Tablelands of New South Wales. The paddock consisted of gently undulating hills predominantly sown to tall fescue (*Festuca arundinacea* var fletcher), with several gullies and isolated timbered areas dominated by native grass species. GPS tracking collars (UNTracker) were deployed on 6 steers in a herd of 220 for a period of 10 days during February and March of 2008. The location of the six animals was logged every five minutes. The positional data collected was analysed in ARC GIS (ESRI, California) to produce diurnal activity graphs to identify the times of peak grazing, and subsequently mapped as a livestock hours index (hours of grazing/animal unit/hectare/day) on a 50m grid.

The diurnal activity of the selected steers was found to be consistent with that observed in other studies, with activity peaking at >250m per hour at two distinct time windows, 5 - 7am and 1pm - 6pm. Observational studies have reported these times to correlate with peak grazing activity. Partitioning the GPS logs into the peak grazing times reveals a map of preferred grazing areas. The results of this trial reveal the preference for the steers to graze gully areas, avoiding the higher elevations in the north-eastern and north-western areas of the paddock. This most likely reflects the green feed found in the gullies during the dry seasonal conditions experienced at the time of this trial. Correlating these data with spatial variability in pasture biomass, soil nutrient analysis and an understanding of the nutrient redistribution by livestock will inform site specific recommendations for fertilizers, water point location and targeted fencing strategies to increase pasture production and utilisation.

Can inter-row sowing be used in continuous wheat systems to control crown rot and increase yield?

A. Verrell, S. Simpfendorfer, P. Nash and K. Moore

NSW Department of Industry and Investment, Tamworth, NSW, Australia

Corresponding Author: andrew.verrell@industry.nsw.gov.au

The Crown rot (CR) fungus *Fusarium pseudograminearum* (*Fp*) survives as mycelium in winter cereal and grass weed residue. The disease can kill tillers and whole plants and can also lead to whiteheads – a symptom associated with small or no grain. CR has increased in the northern NSW cropping region since 1985 and this appears linked to the use of susceptible wheat varieties, the expansion of residue retention systems and continuing to sow wheat on wheat.

This suggests that CR inoculum should remain concentrated in the previous cereal rows, providing the cereal residue is not disturbed and redistributed. This raises the question: Can this spatial distribution of inoculum be used to reduce disease in a following wheat crop by: (i) deliberately sowing into the inter-row space between the previous stubble rows, and (ii) does any advantage persist in subsequent inter-row sown crops?

In 2005, under zero-tillage, durum wheat was sown between the old durum cereal rows (from 2004) which resulted in a 9% yield advantage and lower incidence of *Fp* compared to durum wheat sown on the previous cereal rows. This outcome was achieved from sowing wheat on wheat which had been preceded (2003) by a break crop (chickpeas).

The second part of the research question was examined in 2006. The aim of this research was to test whether a similar result could be attained by stretching the continuous cereal cropping sequence further by sowing a third wheat crop. So in this experiment the inter-row durum treatment was being sown where the durum crop had been two years before (2004). The question then arises is a two year break long enough to ensure low levels of disease in the inter-row area and a significant yield advantage. The effect of a tyne versus disc opener ground engaging tool was also tested to see if they had any effect on the incidence and severity of CR.

The incidence of *Fp* was lower between the previous cereal rows compared to sowing directly on the previous cereal rows but this did not translate, directly, into a yield advantage. The pre-sow DNA sampling showed very high *Fp* inoculum levels across the site both between and within the cereal rows. This very high inoculum load is reflected in the extreme levels of *Fp* infection both between (67%) and within rows (83%).

Using a tyne resulted in a higher grain yield compared to a disc opener. This yield advantage may be due to the ‘excavating’ effect of the tyne removing inoculum from the seed slot as opposed to the disc which operates on minimum disturbance. This advantage was most evident when wheat was sown between the previous cereal rows with the tyne having a 10% yield advantage over the disc opener.

These experiments have shown that inter-row sowing will not provide a yield advantage under a continuous cereal cropping system. The CR inoculum is too persistent under our environmental conditions where zero-tillage is practiced.

The biggest yield gains were recorded where wheat followed a pulse or *Brassica* break-crop. Inter-row planting is simply another tool that can be used in conjunction with a well planned and diverse crop sequencing strategy.

Use of hand-held and in-line near infrared spectroscopy unit for non-invasive fruit quality assessment

K.B. Walsh^A, P.P. Subedi^A, G. Brown^B and P. Purdy^C

^A Central Queensland University, Rockhampton, Australia

^B Colour Vision Systems, Bacchus Marsh, Victoria, Australia

^C Integrated Spectronics, Sydney, Australia

Corresponding Author: k.walsh@cqu.edu.au

Near infrared spectroscopy (NIRS) can be used to assess fruit dry matter content or Brix, and in some cases flesh colour, of thin skinned fruit. Further, spectra of green starch containing fruit such as mango can be used to accurately predict Brix of the ripened fruit, and, by association, also flavour. Our group has been developed both in-packline systems ('InSight', capable of sorting fruit at rates of up to 10 items per second) and hand held, portable NIRS unit ('Nirvana'). These units operate over a wavelength range of 400-1050 nm, with a wavelength resolution of approximately 10 nm and a pixel resolution of 3.3 nm, and repeatability (stand deviation) of approximately 500 micro Absorbance units, with specifications maintained on the handheld unit when operating in ambient field conditions (varying light and temperature). In general, calibration models are relatively robust across growing regions for dry matter, but regional models may be required for flesh colour. Application examples include: (a) monitoring fruit maturation of select (tagged) fruit in a given orchard in the weeks leading up to harvest; (b) assessment of average fruit maturity across blocks; (c) assessment variability in fruit maturation in relation to canopy position; (d) monitoring of picking crew effectiveness (e.g. maturity of fruit in bin relative to that of fruit remaining on tree) and (e) lot analysis of incoming consignments at a pack-house. Fruit assessed as of high dry matter or flesh colour also ripen quicker than low dry matter / flesh colour fruit, to fruit of lower Brix and perceived flavour.

Issues around pasture quality and production measurement systems

I. Yule^A, R. Pullanagari^A, D. Dalley^B, W. King^C and R. Dynes^C

^A Massey University, Palmerston North, New Zealand

^B DairyNZ, New Zealand

^C AgResearch, New Zealand

Corresponding Author: I.J.Yule@massey.ac.nz

There are a number of pasture measurement systems now available to farmers and more undergoing evaluation. These provide surrogate measurements, that is, they quantify one parameter, which is relatively easy to measure (e.g. height), and this is calibrated against another characteristic that is required for management purposes such as pasture mass or pasture energy (ME) content. In this way, useful information can be gathered about the pasture that would be impossible or uneconomic to produce through the direct measurement of that parameter. There are a number of sampling and calibration issues that need to be addressed with these measurement devices and these are discussed.

Pasture sward presents added difficulties when compared to other situations where indirect measurement occurs routinely, such as cropping. Cropping generally involves a monoculture where all the plants are of the same age and growth stage, they are the same variety and there is an absence of weeds or, these techniques are used to detect weeds. Pasture changes as it regrows following grazing and also as it matures through the seasons. Both these factors will vary according to management such as grazing regime, fertiliser use etc. Assuming reliable methods of data collection can be established, large calibration data sets are required. It is unclear at this stage whether a single annual calibration for estimating pasture mass can be achieved from measuring pasture height or reflectance for example, as indications are that the relationship between the surrogate variable and pasture mass changes substantially throughout the year. Early work indicates that there is still significant work required.

The authors have conducted a number of studies and one factor that has emerged is that management effects can be observed: pastures that are considered to be well managed are measurably different to others. This information can be used by the farmer to assist their management process and drive it within tighter limits than previously possible thereby gaining significant benefit. The work is funded from a number of sources including the Pastoral 21 Feed programme.

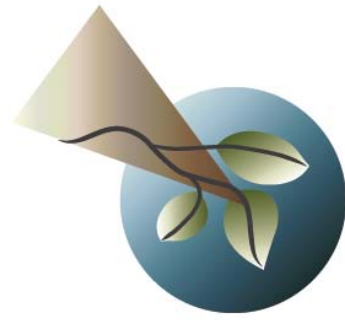

10th International Conference on

Precision Agriculture

JULY 18-21, 2010 • Hyatt Regency Tech Center
Denver Colorado USA

www.icpaonline.org



Conference Chairperson

Dr. Rajiv Khosla, Colorado State University
ICPA@Colostate.Edu

Organizing Committee

Dr. Harold Reetz, International Plant Nutrition Institute/
Foundation for Agronomic Research
Dr. Dwayne Westfall, Colorado State University
Mr. Quentin Rund, PAQ Interactive

Conference Coordination

PAQ Interactive

Welcome Message

Dear International Precision Agriculture Community:

It is a great pleasure for me to announce the **10th International Conference on Precision Agriculture (ICPA)** to be held at the Hyatt Regency Tech Center in Denver, Colorado, USA from July 18th to July 21st, 2010.



It is an honor and a matter of pride for Denver, the mile high city that is nestled in the heart of the USA, surrounded by the Rocky Mountain National Park on the west to the Great Plains on the east, to once again host the ICPA conference in its technological hub "The Denver Tech Center."

Precision agriculture is growing and so is the precision agricultural community across the world. The 10th International Conference on Precision Agriculture is envisaged to be the largest ever, with more than 500 attendees from all over the US and over 40 countries (see program details, coming soon on www.icpaonline.org).

As with previous ICPA conferences, the **10th International Conference on Precision Agriculture** will provide a forum for presentations on the current state of precision agriculture research and applications. The conference will facilitate interaction among research scientists, producers, technology company representatives, equipment manufacturers, input dealers, agronomic consultants, software developers, educators, government personnel and policymakers.

The 10th ICPA conference will honor the achievements of a young and senior scientist with the "P.C. Robert Young and Senior Scientist Award." In addition, we plan to offer several awards in the graduate student category to recognize their work and encourage participation in the ICPA conference.

We are looking forward to seeing you at the **10th International Conference on Precision Agriculture** in Denver, Colorado, USA.

Sincerely yours,

Raj Khosla
Chair of the 10th International Conference on Precision Agriculture
Colorado State University Monfort Professor

Overview of the Program

Plenary session will set the stage for the conference with keynote speakers who will challenge us to use innovative techniques and technologies to expand our knowledge in production systems.

Concurrent sessions will feature researchers from across the globe. Each will present on their current studies into various aspects of precision agriculture. Six concurrent sessions will provide ample opportunity to hear presentations of interest to each attendee. One of the concurrent sessions "Precision A to Z Track for Practitioners," will be focused on practical advice for producers and professionals on key topics of precision agriculture.

Poster session will offer another forum for "one to one" interaction among presenters, scientists, students, and others in attendance to discuss their work in precision agriculture.

Exhibit hall will feature companies with the hardware and services that make technology in the field feasible. Companies with products specifically designed for researchers, practitioners and producers will be featured.



10th International Conference on
Precision Agriculture
JULY 18-21, 2010 • Hyatt Regency Tech Center
Denver Colorado USA





2010 USA Nitrogen Use Efficiency Conference

9th-11th August

This group began meeting together in 1996 (Nebraska-Oklahoma). This was expanded to include Virginia Tech and CIMMYT-Mexico in 1998. By 2003, this group included most mid-west Universities in the corn belt, and has since met every year at different institutions. Participants have included individuals from Canada, Argentina, Mexico, Australia,



Germany, and Brazil. In 2010 the group will again meet in Stillwater, OK. Originally designed as a “workshop,” discussions and presentations were built



around sensor based methodologies that could increase nitrogen use efficiency in cereal production systems. Both engineering and agronomic problems continue to be addressed by this group that hopes to deliver “by-plant” N management.

http://nue.okstate.edu/Nitrogen_Conference2010/Oklahoma.htm

28th Conference of the Australian Society of Animal Production

12-15 July 2010

“Livestock Production in a Changing Environment”

The University of New England Armidale NSW Australia

Special theme “Precision Livestock Management”



ASAP is a national organisation of people dedicated to managing, developing and promoting the advancement of livestock production in Australia.

Its Mission is to promote the best interests of Australian livestock production research and development, enterprise management, and industries

reliant on animals for food, fibre and recreation. Within ASAP, members work together to:

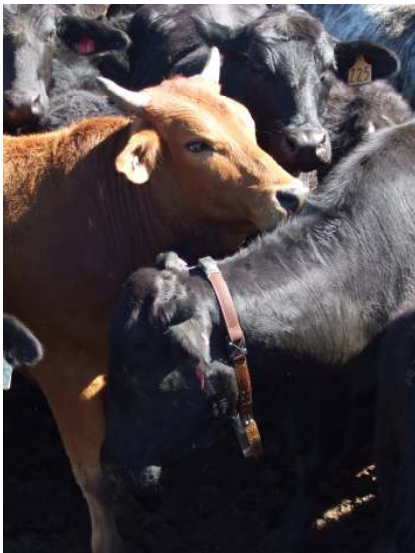

discover, acquire, develop and share information, ideas and contacts; and

identify and tackle issues which involve or impact on the sustainable success of animal production. ASAP concerns itself with all facets of animal industry, including scientific endeavour and commercial enterprise.



www.asap.asn.au/asap28/

Graduate Certificate in Rural Science (Agricultural Consulting)

Study by distance from the University of New England
2 core & 2 elective subjects in up to 2 years



Whether you already work in agricultural consulting, extension or other advisory roles, or you are planning to, the Graduate Certificate in Rural Science (Agricultural Consulting) offers professional development, vocational and technical skills that cross agricultural disciplines.



Core units

CSLT 501 Business Skills for Agricultural Consultants

- Strategic planning for a successful business
- Media
- Legal Issues

CSLT 502 Client Service Skills for Agricultural Consultants

- Whole of enterprise planning
- Communication, facilitation and negotiation

Wide choice of electives including Precision Agriculture (ENVE 335/535)

And subjects in these fields: Agricultural Systems ♦ Agronomy ♦ Animal Health & Welfare ♦ Animal Nutrition ♦ Aquatic Ecology & Management ♦ Botany ♦ Conservation Biology ♦ Earth Sciences ♦ Ecology ♦ Ecosystem Management ♦ Environmental Engineering ♦ Genetics ♦ Geographic Information Systems ♦ Marine Science & Management ♦ Meat Science ♦ Palaeontology ♦ Poultry Science ♦ Soil Science ♦ Sustainable Farming ♦ Systematics ♦ Wildlife Ecology & Management ♦ Wool Science and Sheep ♦ Zoology

Find out more: www.sheepcrc.org.au/ed-gcagconsult

Contact the unit coordinator: Deb Maxwell

deborah.maxwell@une.edu.au 02 6779 4262

The 13th Annual Symposium on Precision Agriculture in Australasia is supported by



www.crcsi2.com.au

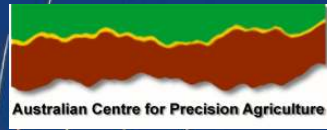

www.usyd.edu.au/agric/acpa



www.grdc.com.au



www.spaa.com.au



www.ecoaus.com.au



www.geosys.com



www.cropoptics.com.au



www.fugrospatial.com.au



www.lreye.com.au



www.une.edu.au/parg



www.intspec.com